

APPLICATIONS

- Variable speed A.C. motor drive inverters (VSD-AC)
- Uninterruptable Power Supplies
- High Voltage Converters
- Choppers
- Welding
- Induction Heating
- DC/DC Converters

FEATURES

- Double Side Cooling
- High Reliability In Service
- High Voltage Capability
- Fault Protection Without Fuses
- High Surge Current Capability
- Turn-off Capability Allows Reduction In Equipment Size And Weight. Low Noise Emission Reduces Acoustic Cladding Necessary For Environmental Requirements

KEY PARAMETERS

I_{TCM}	600A
V_{DRM}	2500V
$I_{T(AV)}$	225A
dV_D/dt	1000V/ μ s
di_T/dt	300A/ μ s

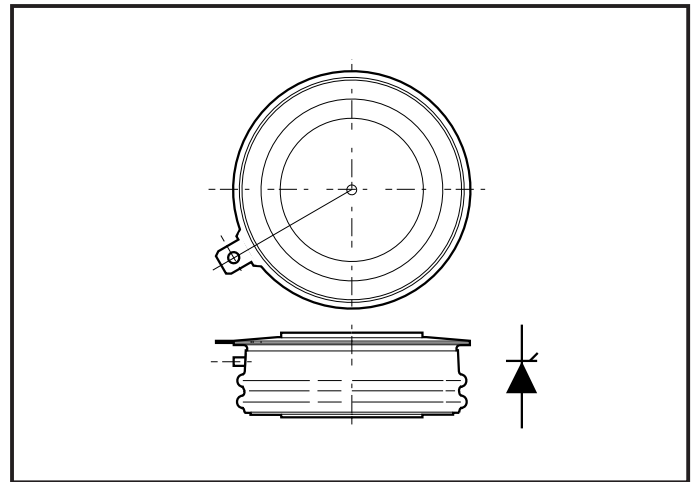

Outline type code: E.
See Package Details for further information.

VOLTAGE RATINGS

Type Number	Repetitive Peak Off-state Voltage V_{DRM} V	Repetitive Peak Reverse Voltage V_{RRM} V	Conditions
DG306AE25	2500	16	$T_{vj} = 125^{\circ}\text{C}$, $I_{DM} = 50\text{mA}$, $I_{RRM} = 50\text{mA}$, $V_{RG} = 2\text{V}$

CURRENT RATINGS

Symbol	Parameter	Conditions	Max.	Units
I_{TCM}	Repetitive peak controllable on-state current	$V_D = 67\%V_{DRM}$, $T_j = 125^{\circ}\text{C}$, $di_{GQ}/dt = 15\text{A}/\mu\text{s}$, $C_s = 1.0\mu\text{F}$	600	A
$I_{T(AV)}$	Mean on-state current	$T_{HS} = 80^{\circ}\text{C}$. Double side cooled. Half sine 50Hz.	225	A
$I_{T(RMS)}$	RMS on-state current	$T_{HS} = 80^{\circ}\text{C}$. Double side cooled. Half sine 50Hz.	350	A

DG306AE25

SURGE RATINGS

Symbol	Parameter	Conditions	Max.	Units
I_{TSM}	Surge (non-repetitive) on-state current	10ms half sine. $T_j = 125^\circ\text{C}$	3.5	kA
I^2t	I^2t for fusing	10ms half sine. $T_j = 125^\circ\text{C}$	61250	A^2s
di_T/dt	Critical rate of rise of on-state current	$V_D = 2000\text{V}$, $I_T = 600\text{A}$, $T_j = 125^\circ\text{C}$, $I_{FG} > 20\text{A}$, Rise time $> 1.0\mu\text{s}$	300	$\text{A}/\mu\text{s}$
dV_D/dt	Rate of rise of off-state voltage	To 66% V_{DRM} ; $R_{GK} \leq 1.5\Omega$, $T_j = 125^\circ\text{C}$	500	$\text{V}/\mu\text{s}$
		To 66% V_{DRM} ; $V_{RG} = -2\text{V}$, $T_j = 125^\circ\text{C}$	1000	$\text{V}/\mu\text{s}$
L_S	Peak stray inductance in snubber circuit	-	200	nH

GATE RATINGS

Symbol	Parameter	Conditions	Min.	Max.	Units
V_{RGM}	Peak reverse gate voltage	This value maybe exceeded during turn-off	-	16	V
I_{FGM}	Peak forward gate current		-	50	A
$P_{FG(AV)}$	Average forward gate power		-	10	W
P_{RGM}	Peak reverse gate power		-	6	kW
di_{GQ}/dt	Rate of rise of reverse gate current		10	50	$\text{A}/\mu\text{s}$
$t_{ON(min)}$	Minimum permissible on time		20	-	μs
$t_{OFF(min)}$	Minimum permissible off time		40	-	μs

THERMAL RATINGS

Symbol	Parameter	Conditions	Min.	Max.	Units
$R_{th(j-hs)}$	DC thermal resistance - junction to heatsink surface	Double side cooled	-	0.075	$^\circ\text{C}/\text{W}$
		Anode side cooled	-	0.12	$^\circ\text{C}/\text{W}$
		Cathode side cooled	-	0.20	$^\circ\text{C}/\text{W}$
$R_{th(c-hs)}$	Contact thermal resistance	Clamping force 6.0kN With mounting compound	-	0.018	$^\circ\text{C}/\text{W}$
		per contact			
T_{vj}	Virtual junction temperature		-	125	$^\circ\text{C}$
T_{OP}/T_{stg}	Operating junction/storage temperature range		-40	125	$^\circ\text{C}$
-	Clamping force		5.0	6.0	kN

CHARACTERISTICS

$T_j = 125^\circ\text{C}$ unless stated otherwise					
Symbol	Parameter	Conditions	Min.	Max.	Units
V_{TM}	On-state voltage	At 600A peak, $I_{G(ON)} = 2\text{A d.c.}$	-	2.75	V
I_{DM}	Peak off-state current	$V_{DRM} = 2500\text{V}$, $V_{RG} = 0\text{V}$	-	50	mA
I_{RRM}	Peak reverse current	At V_{RRM}	-	50	mA
V_{GT}	Gate trigger voltage	$V_D = 24\text{V}$, $I_T = 100\text{A}$, $T_j = 25^\circ\text{C}$	-	0.9	V
I_{GT}	Gate trigger current	$V_D = 24\text{V}$, $I_T = 100\text{A}$, $T_j = 25^\circ\text{C}$	-	1.0	A
I_{RGM}	Reverse gate cathode current	$V_{RGM} = 16\text{V}$, No gate/cathode resistor	-	50	mA
E_{ON}	Turn-on energy	$V_D = 2000\text{V}$	-	515	mJ
t_d	Delay time	$I_T = 600\text{A}$, $dI_T/dt = 300\text{A}/\mu\text{s}$	-	1.5	μs
t_r	Rise time	$I_{FG} = 20\text{A}$, rise time $< 1.0\mu\text{s}$	-	3.0	μs
E_{OFF}	Turn-off energy		-	1000	mJ
t_{gs}	Storage time		-	11.4	μs
t_{gf}	Fall time	$I_T = 600\text{A}$, $V_{DM} = 2000\text{V}$	-	1.5	μs
t_{gq}	Gate controlled turn-off time	Snubber Cap $C_s = 1.0\mu\text{F}$,	-	12.9	μs
Q_{GQ}	Turn-off gate charge	$dI_{GQ}/dt = 15\text{A}/\mu\text{s}$	-	1300	μC
Q_{GQT}	Total turn-off gate charge		-	2600	μC
I_{GQM}	Peak reverse gate current		-	190	A

CURVES

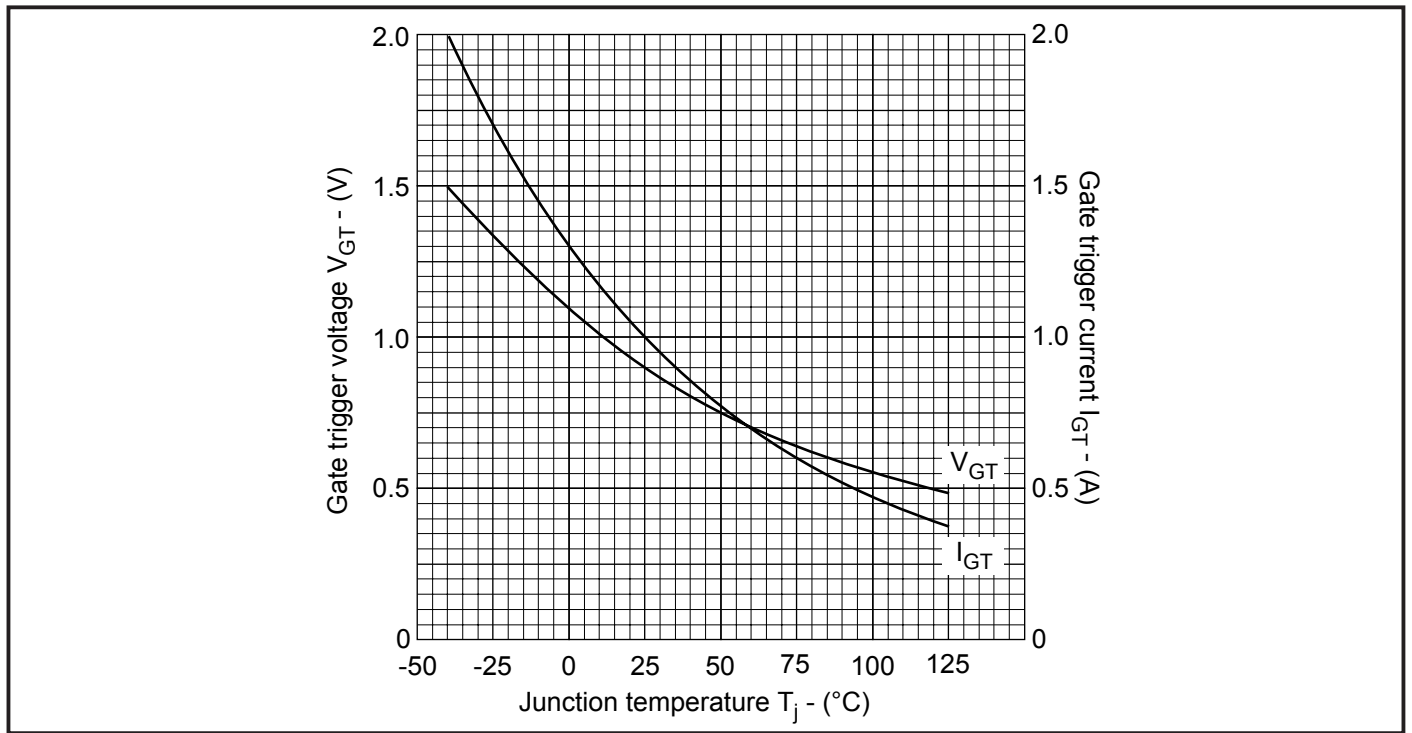

Fig.1 Gate trigger voltage/current vs junction temperature

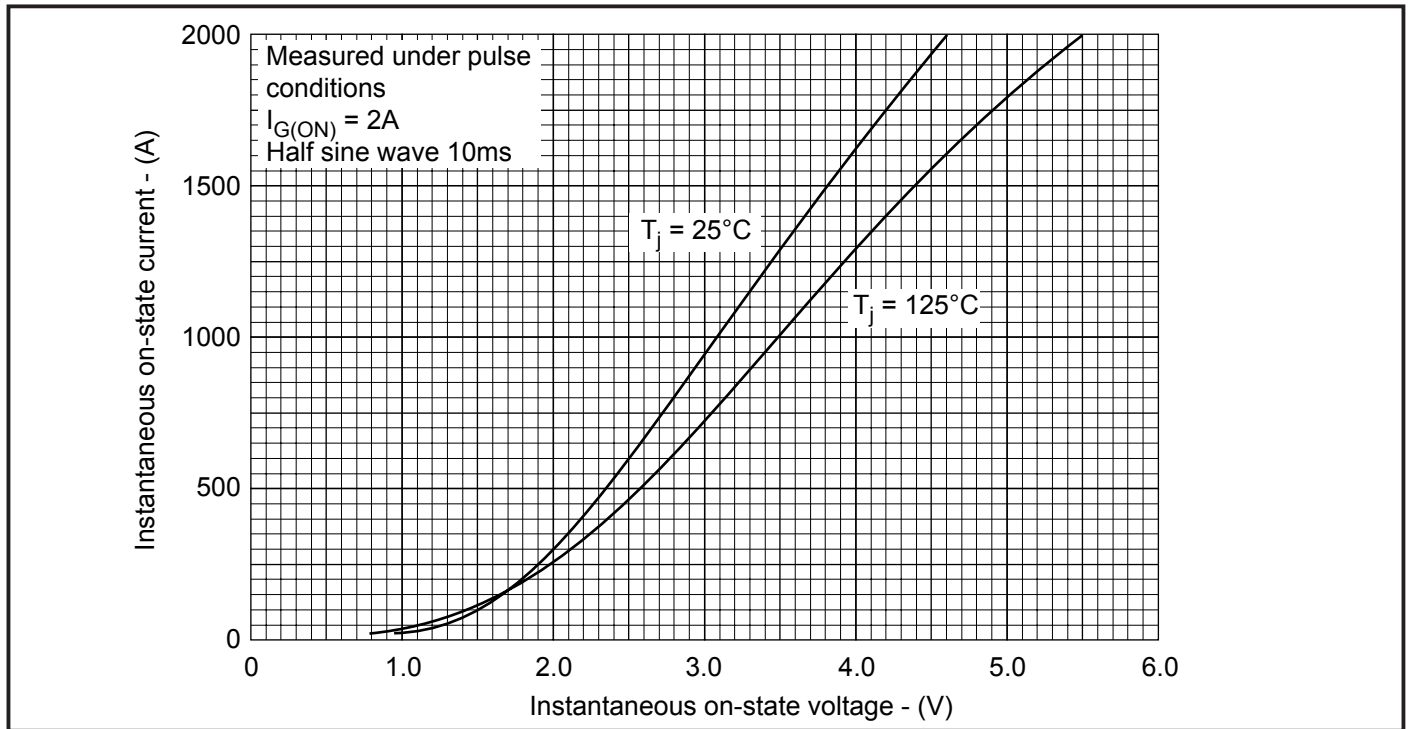

Fig.2 Maximum limit on-state characteristics

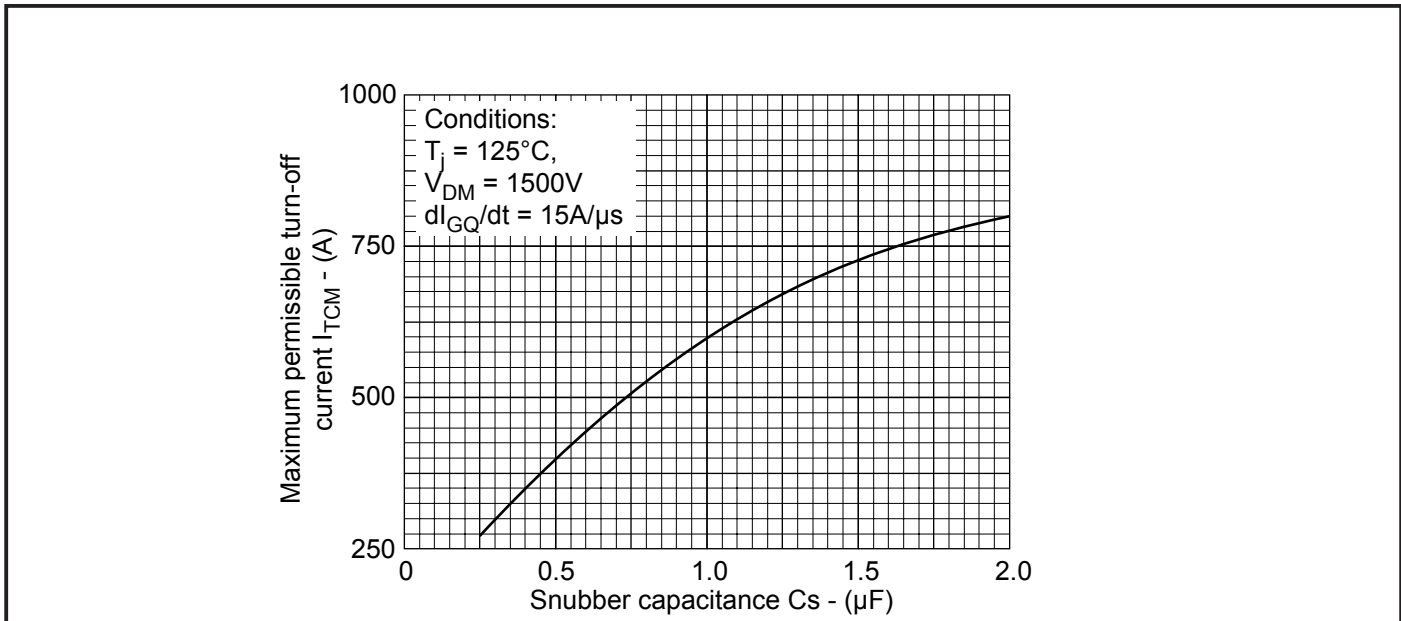

Fig.3 Dependence of I_{TCM} on C_s

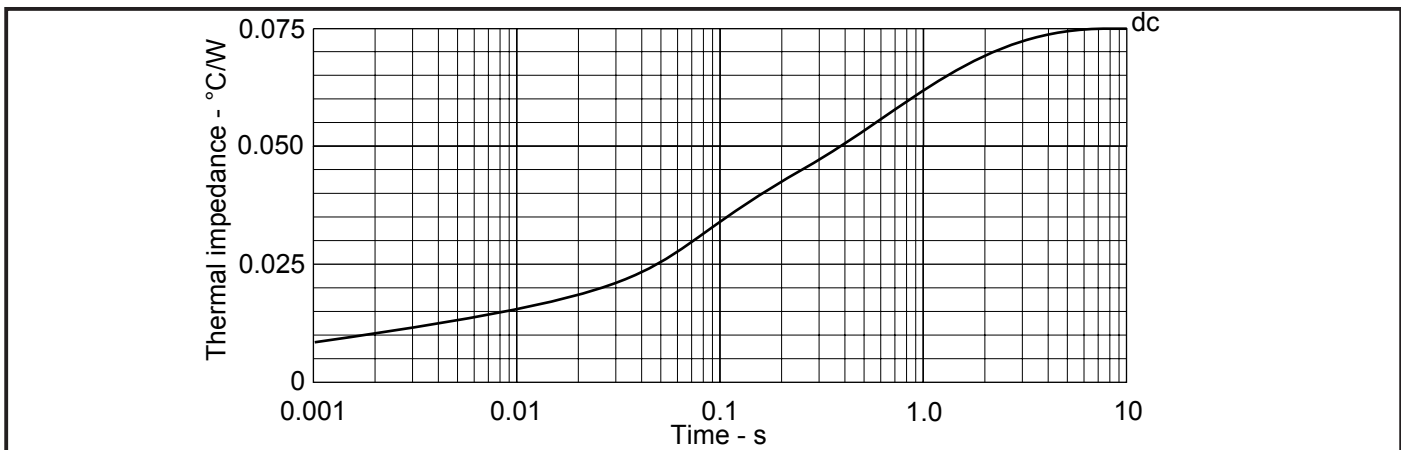

Fig.4 Maximum (limit) transient thermal impedance - double side cooled

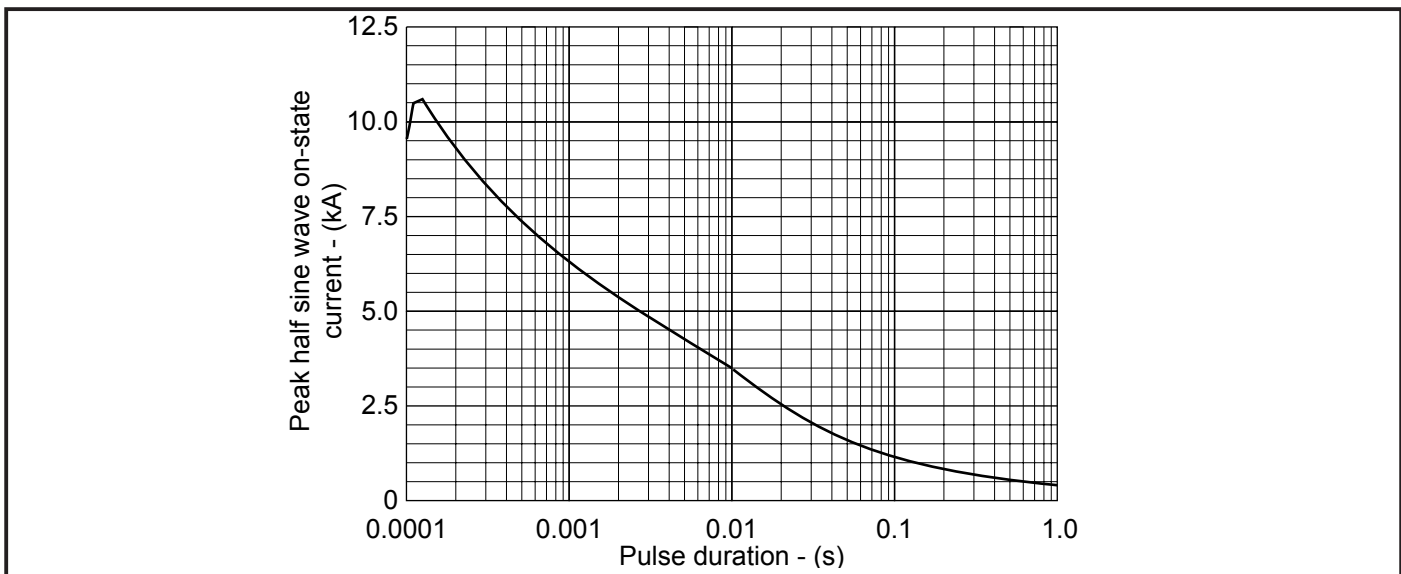

Fig.5 Surge (non-repetitive) on-state current vs time

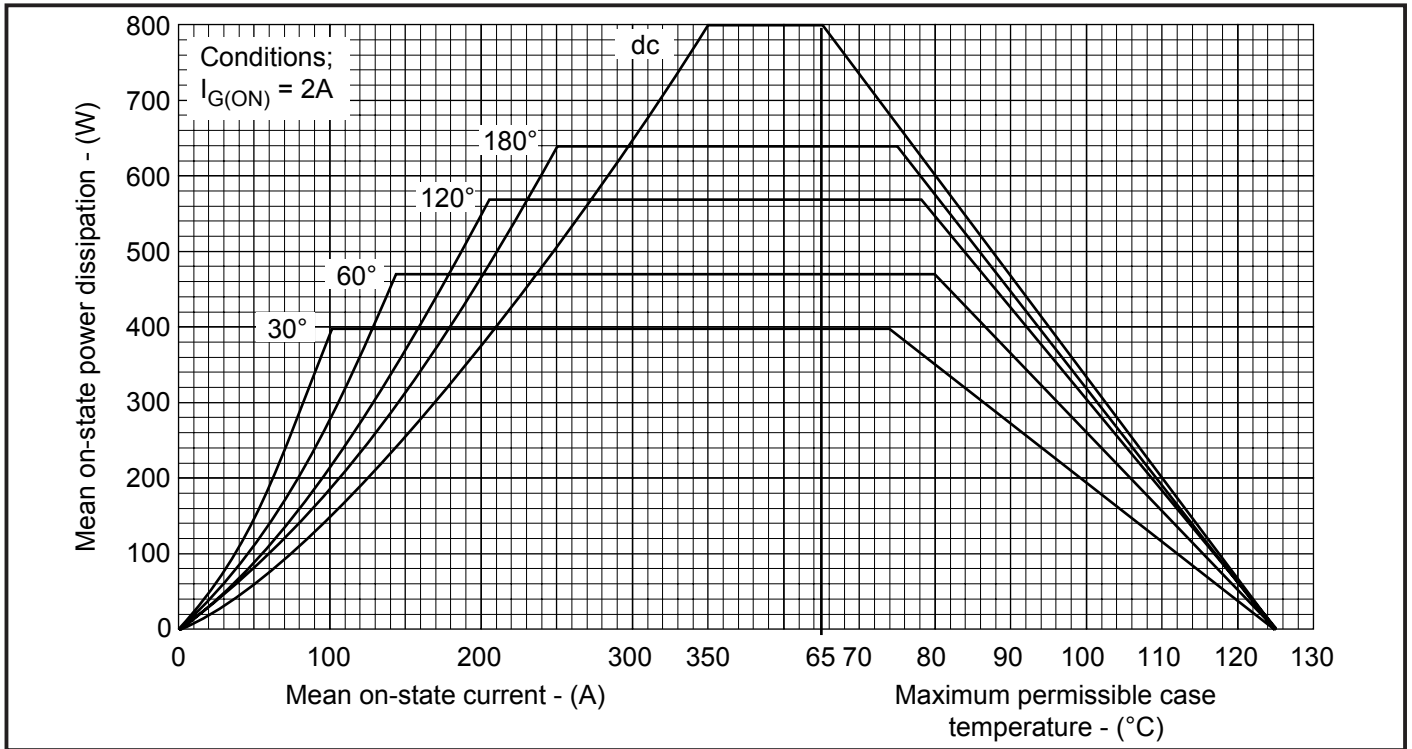

Fig.6 Steady state rectangular wave conduction loss - double side cooled

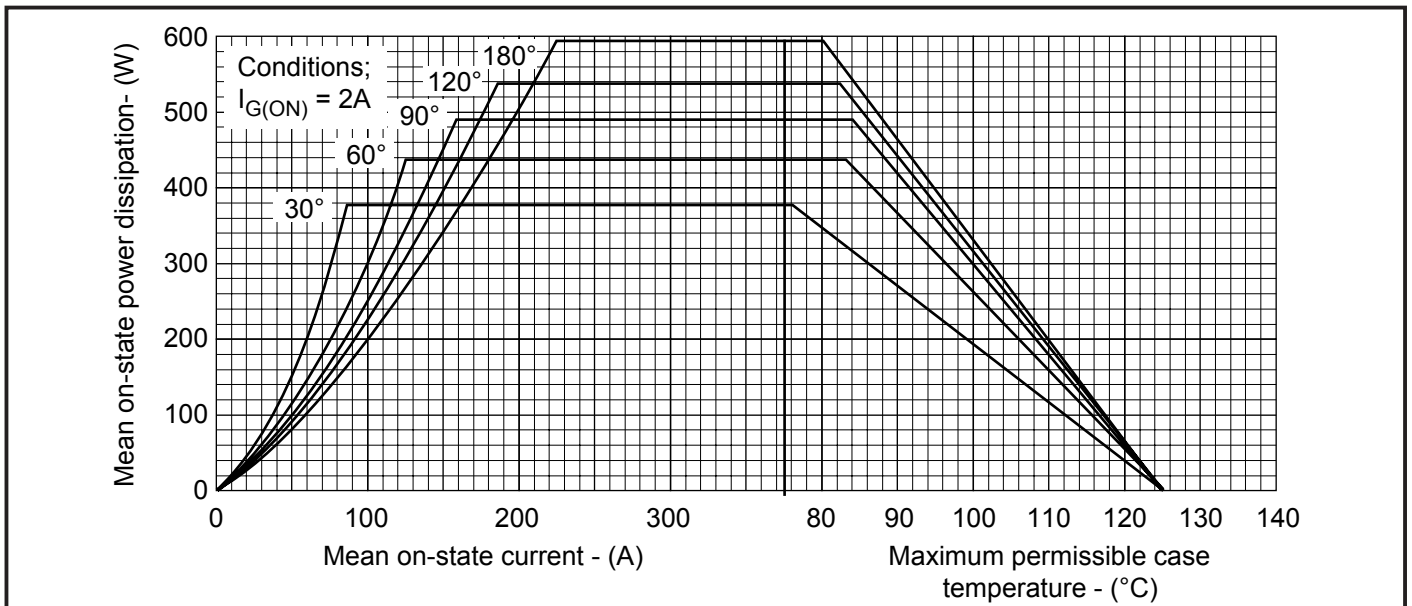

Fig.7 Steady state sinusoidal wave conduction loss - double side cooled

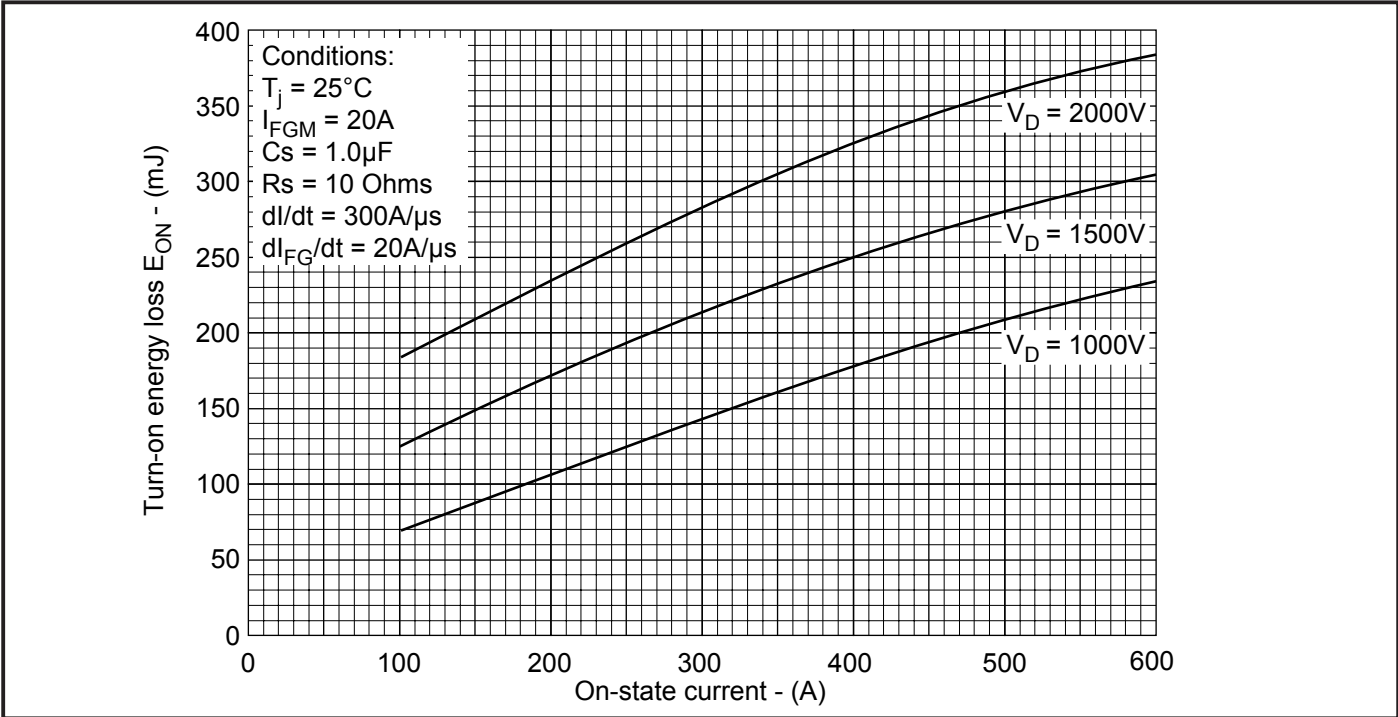

Fig.8 Turn-on energy vs on-state current

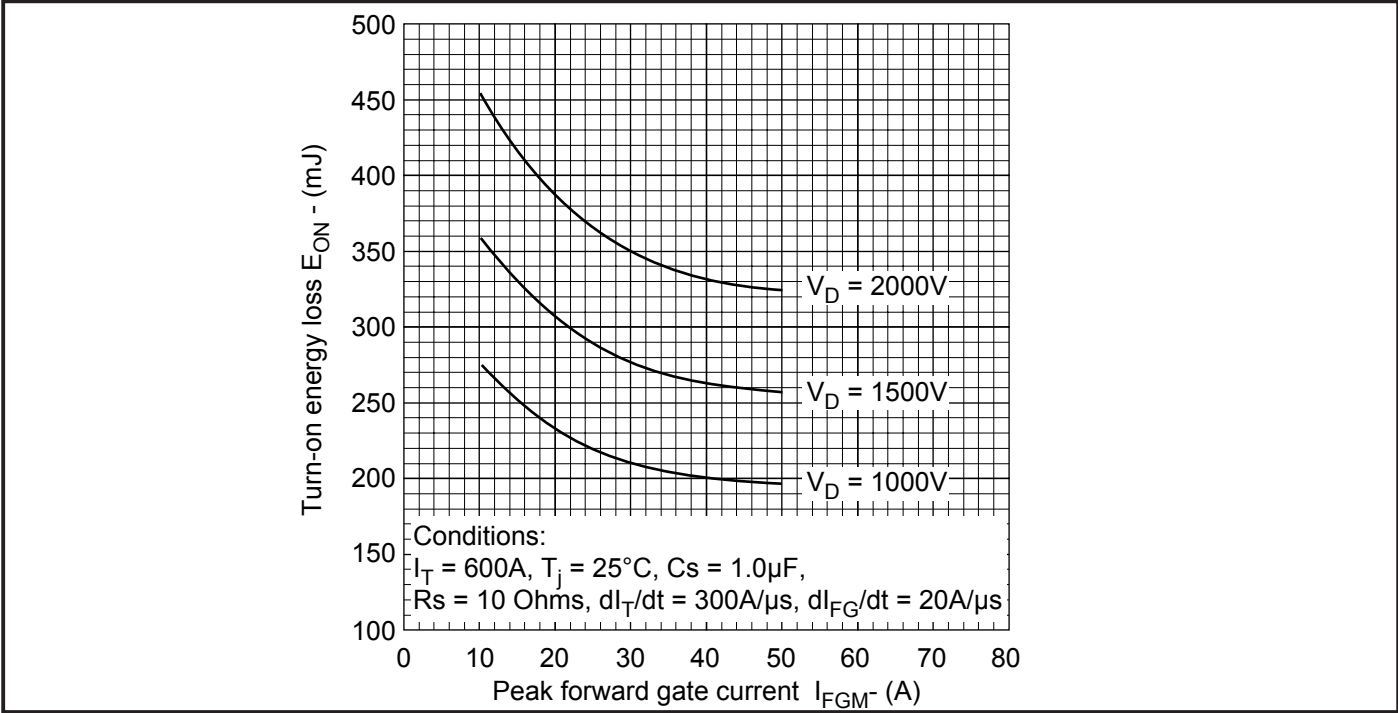

Fig.9 Turn-on energy vs peak forward gate current

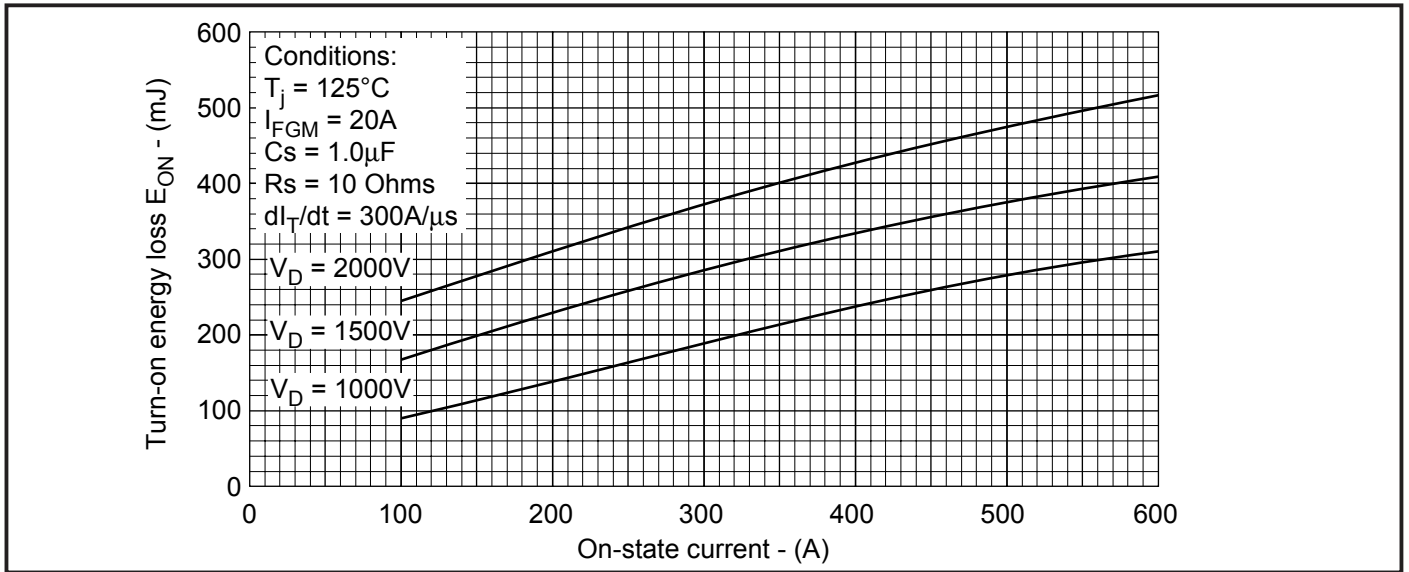

Fig.10 Turn-on energy vs on-state current

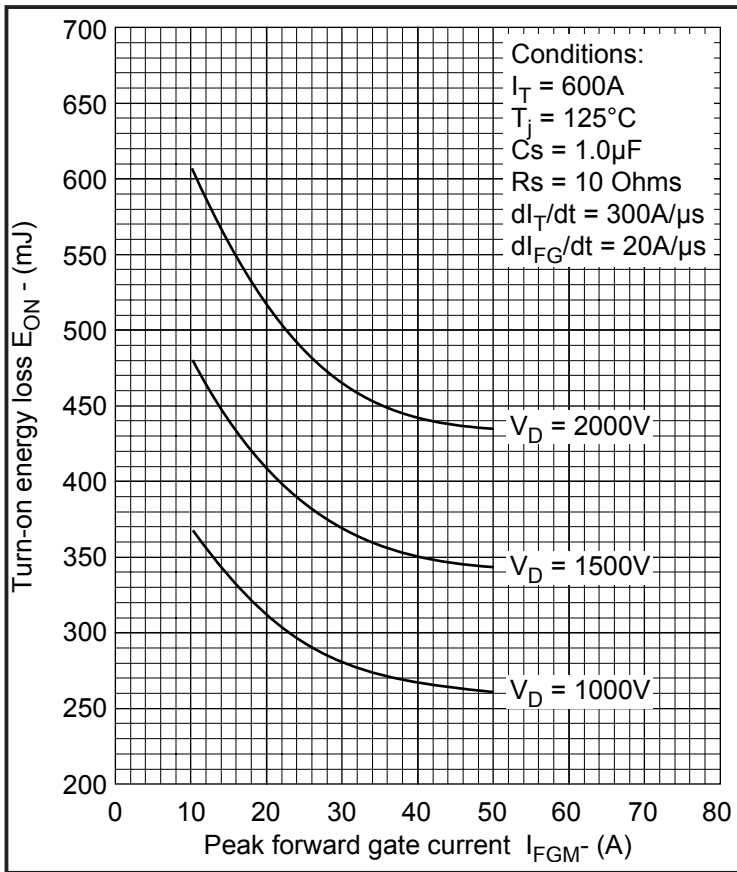

Fig.11 Turn-on energy vs peak forward gate current

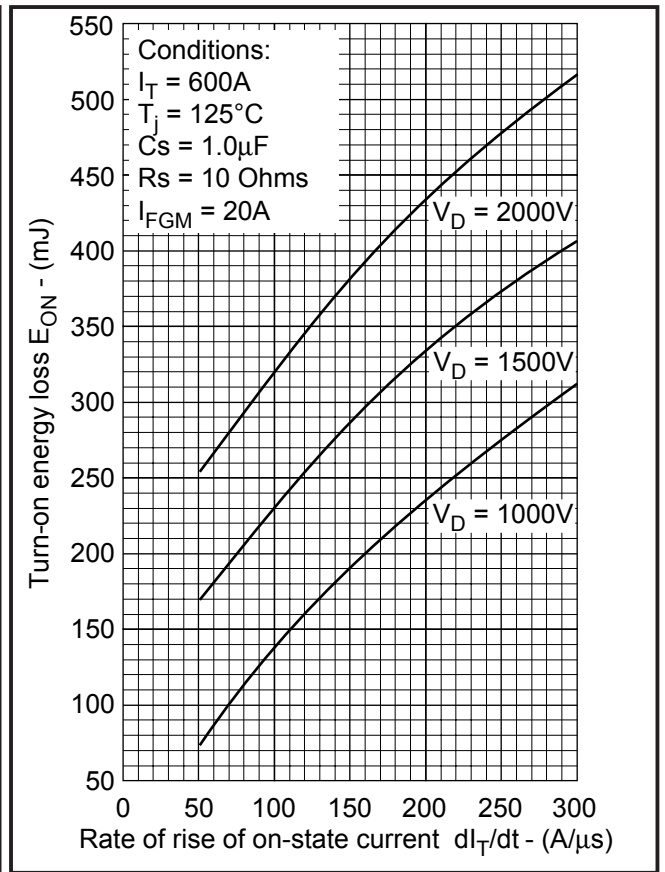

Fig.12 Turn-on energy vs rate of rise of on-state current

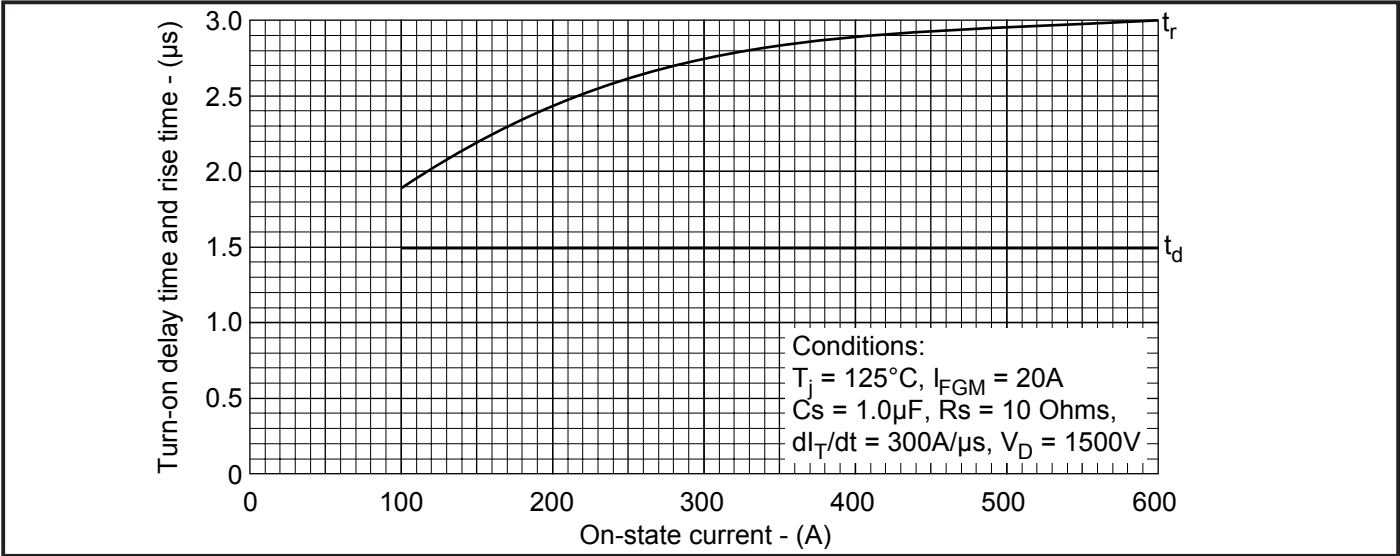

Fig.13 Delay & rise time vs turn-on current

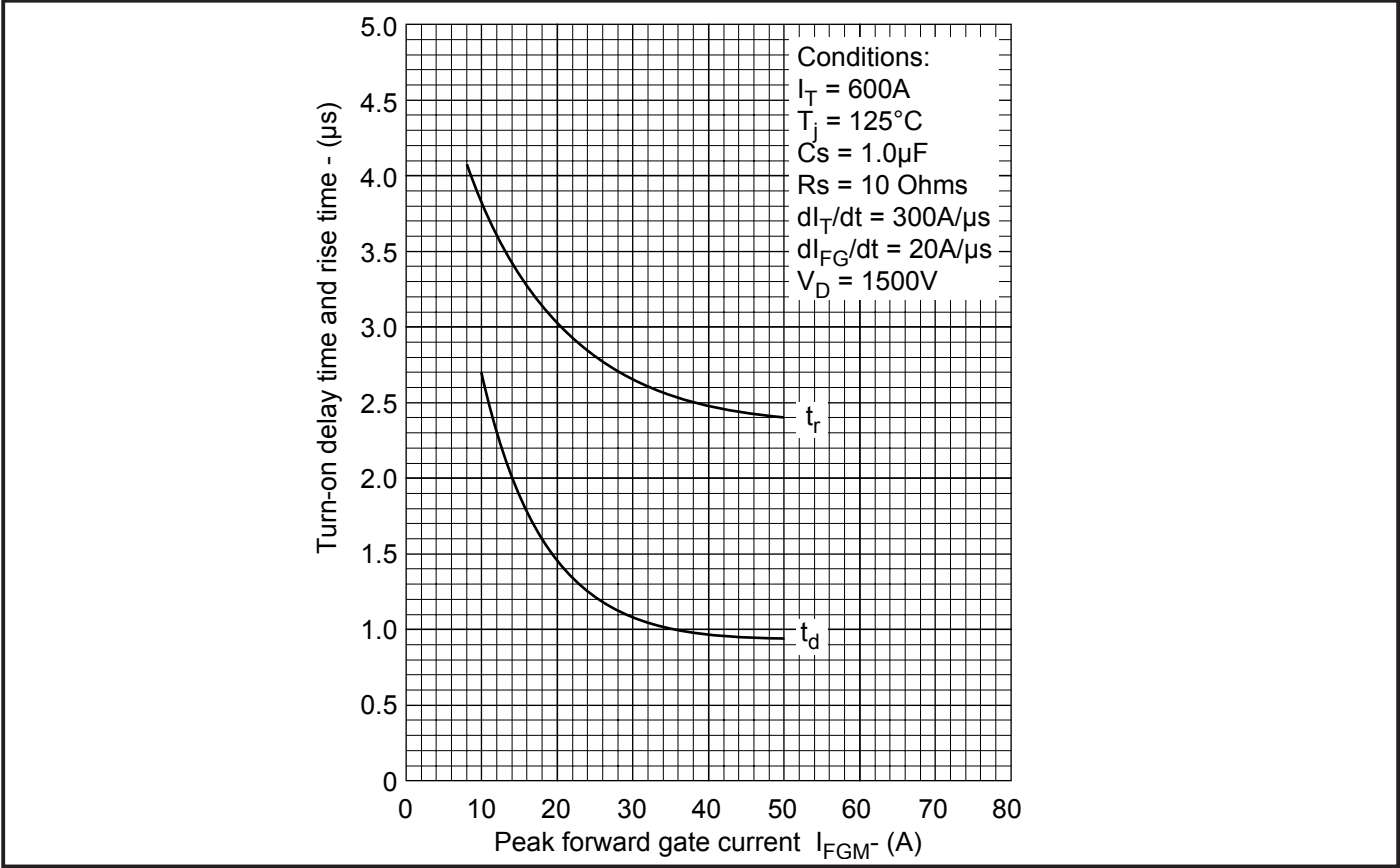

Fig.14 Delay time & rise time vs peak forward gate current

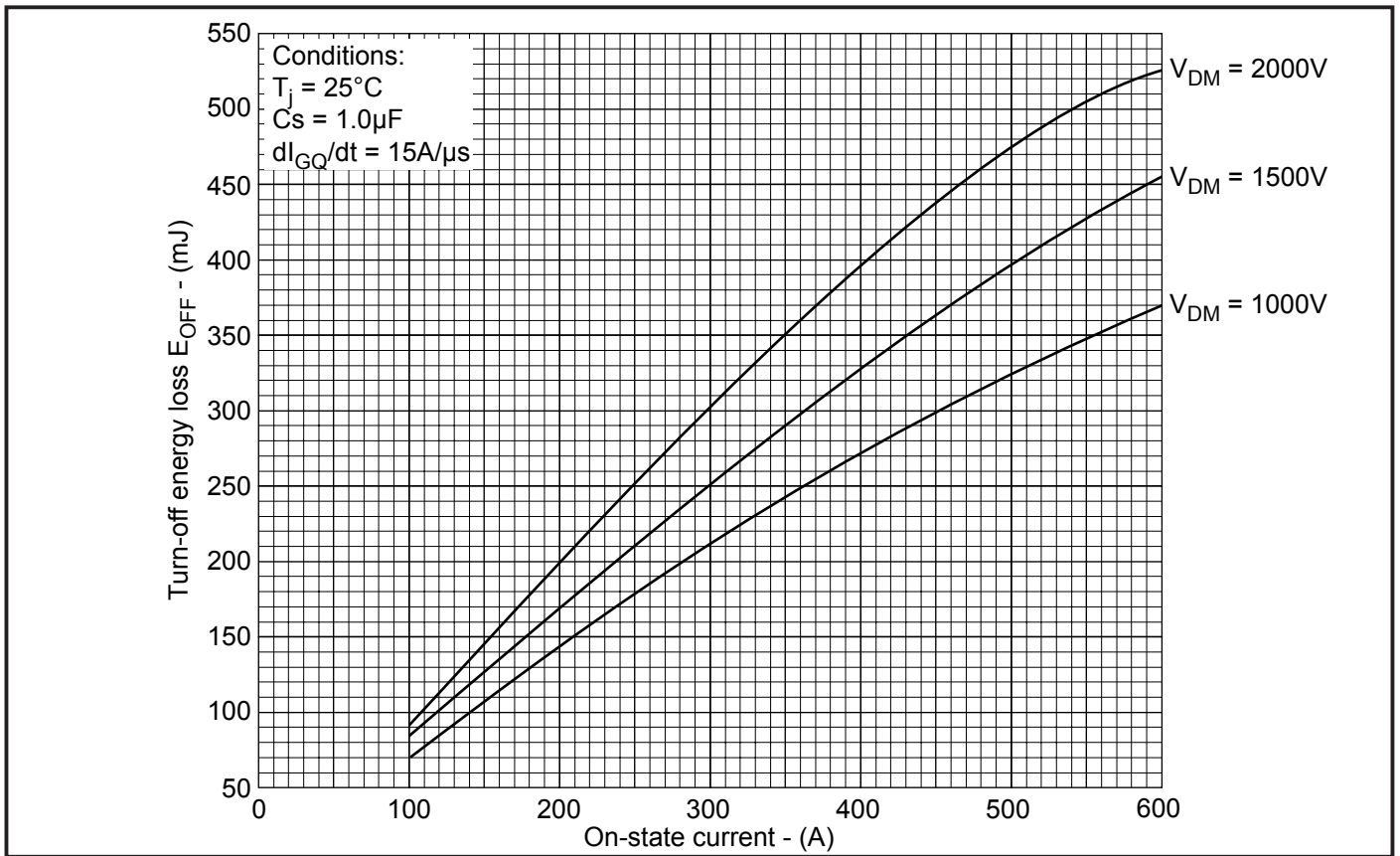

Fig.15 Turn-off energy loss vs on-state current

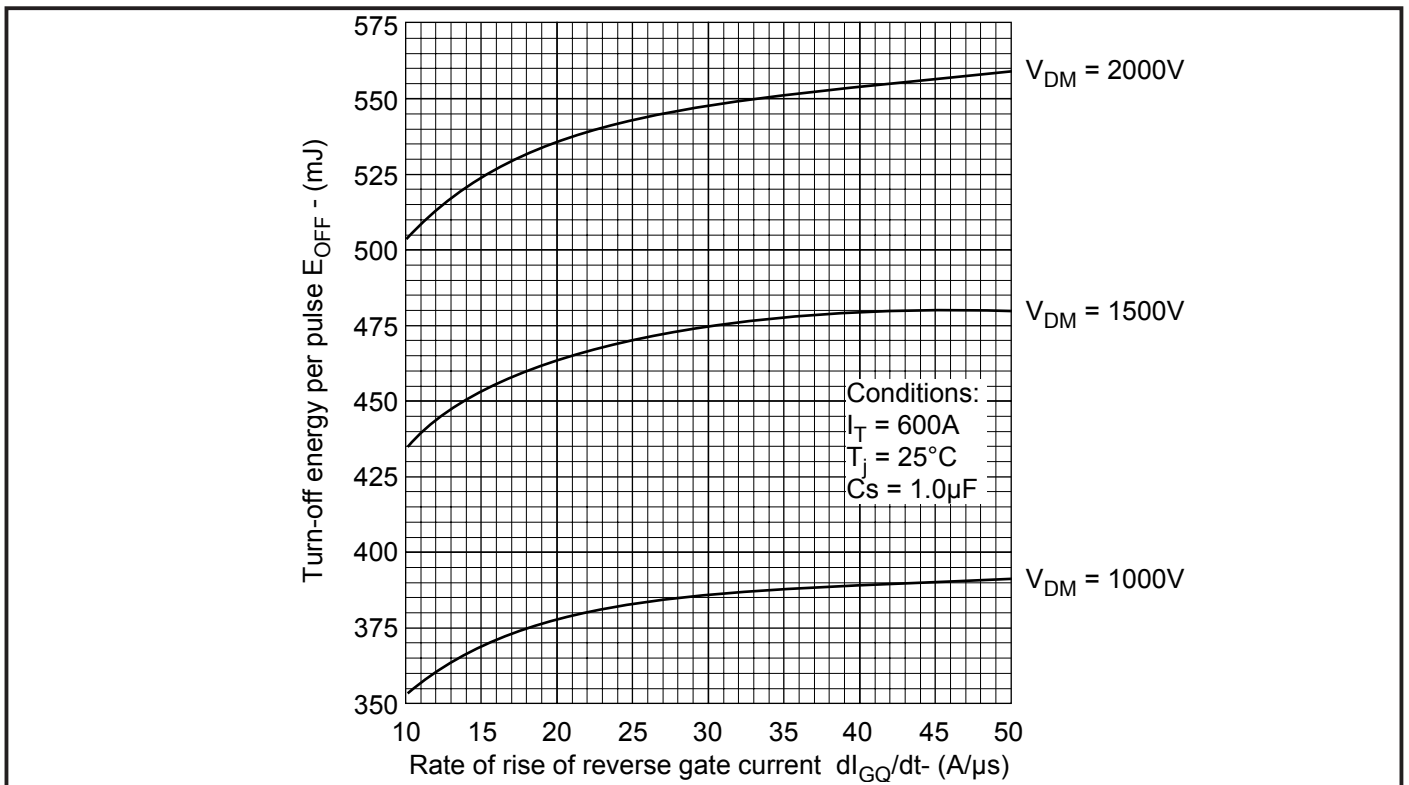

Fig.16 Turn-off energy vs rate of rise of reverse gate current

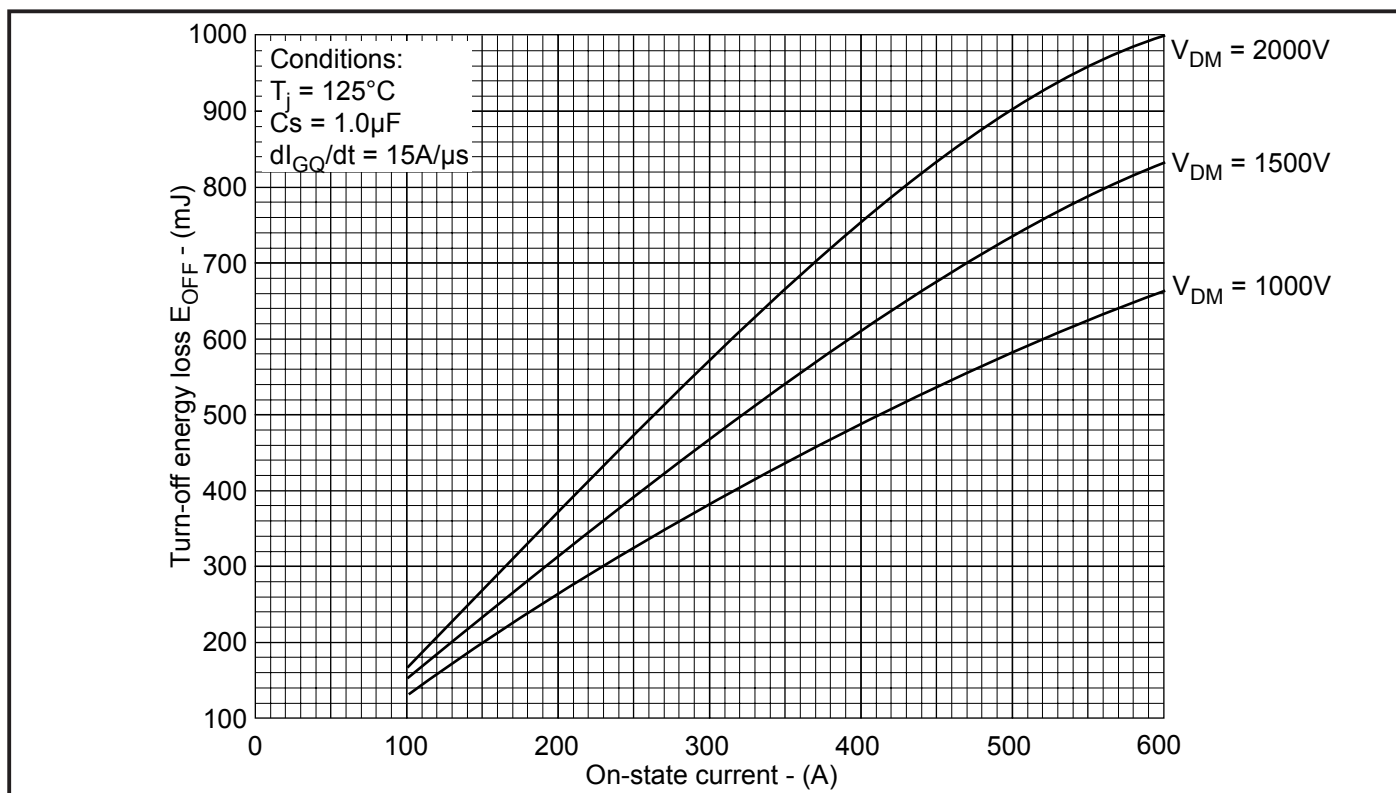

Fig.17 Turn-off energy vs on-state current

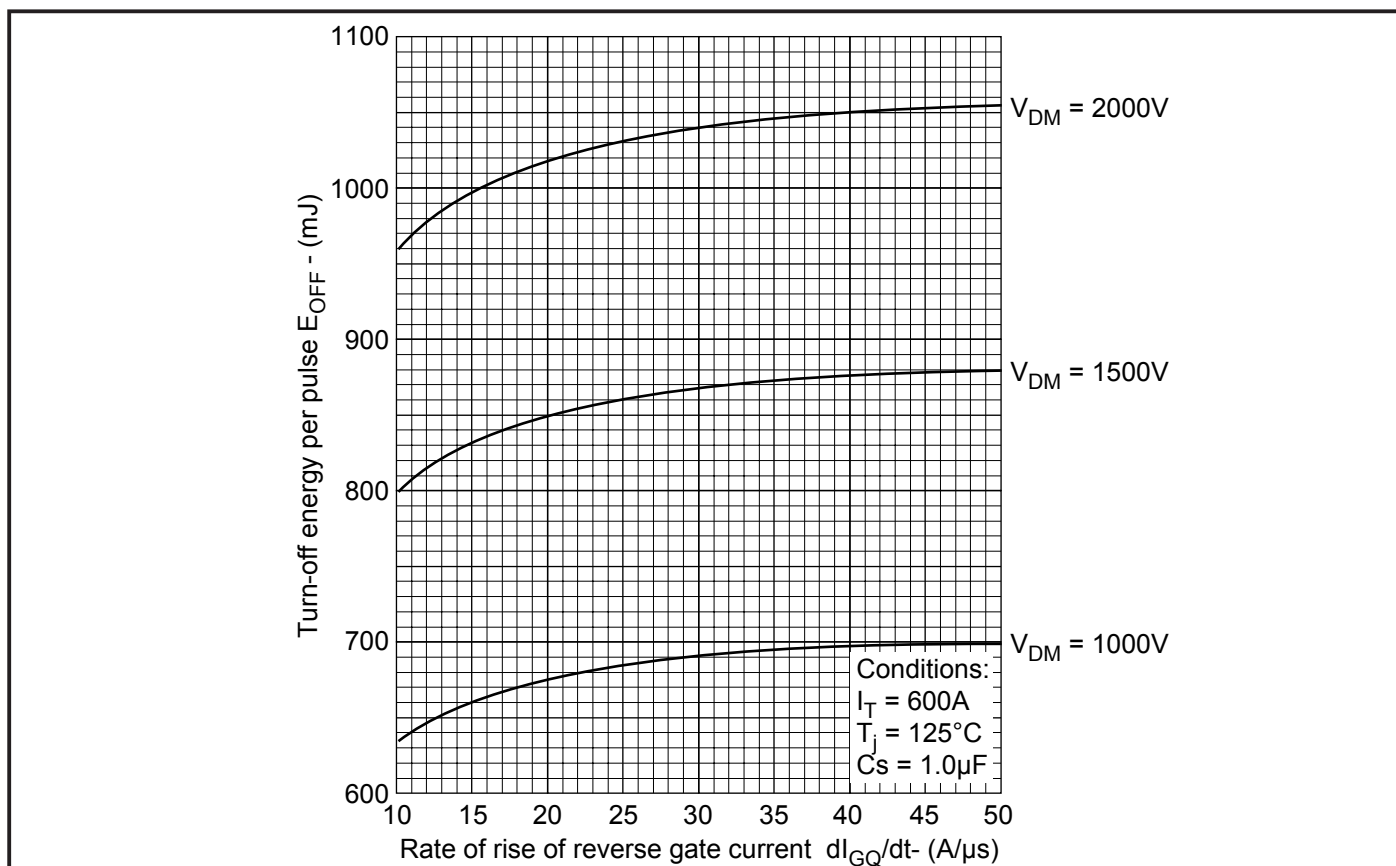

Fig.18 Turn-off energy loss vs rate of rise of reverse gate current

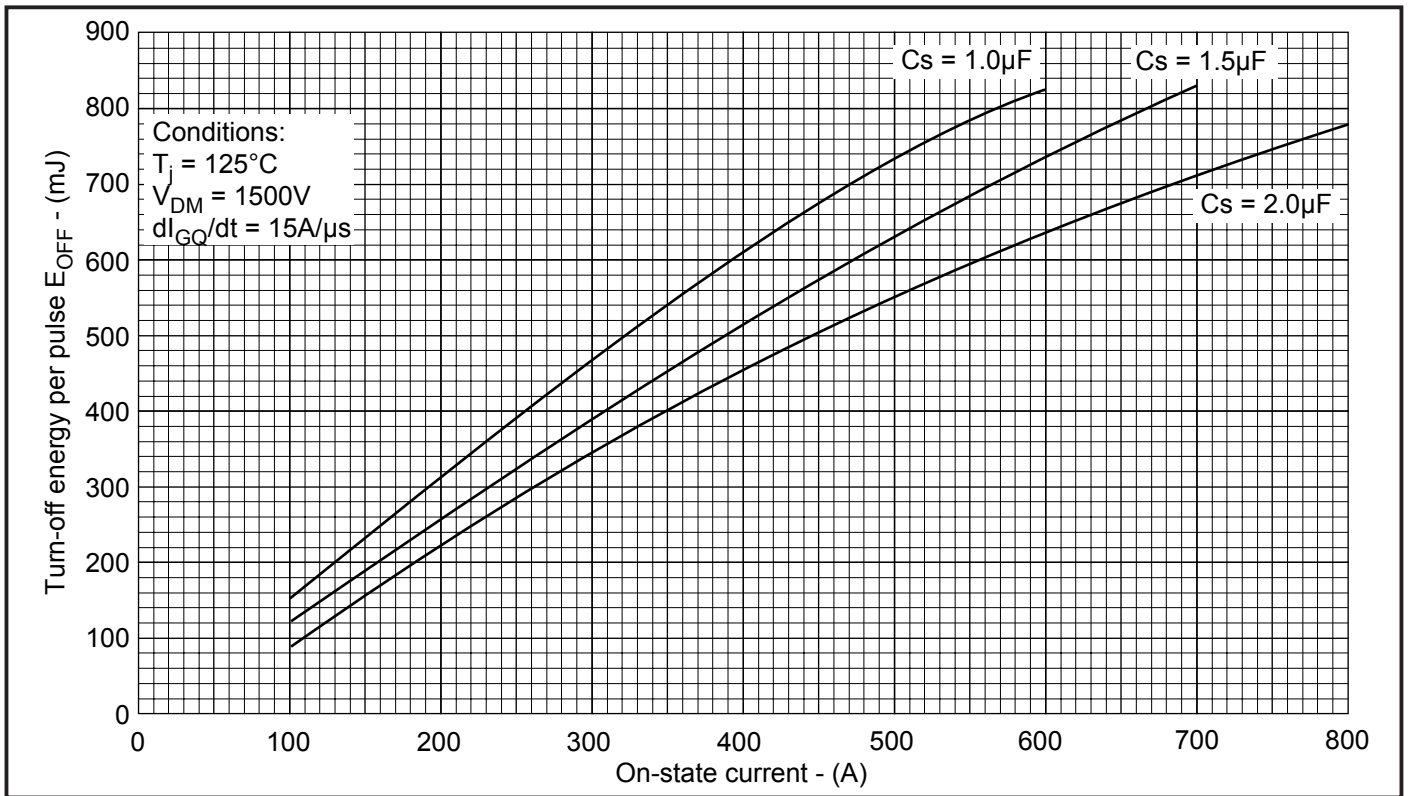

Fig.19 Turn-off energy vs on-state current

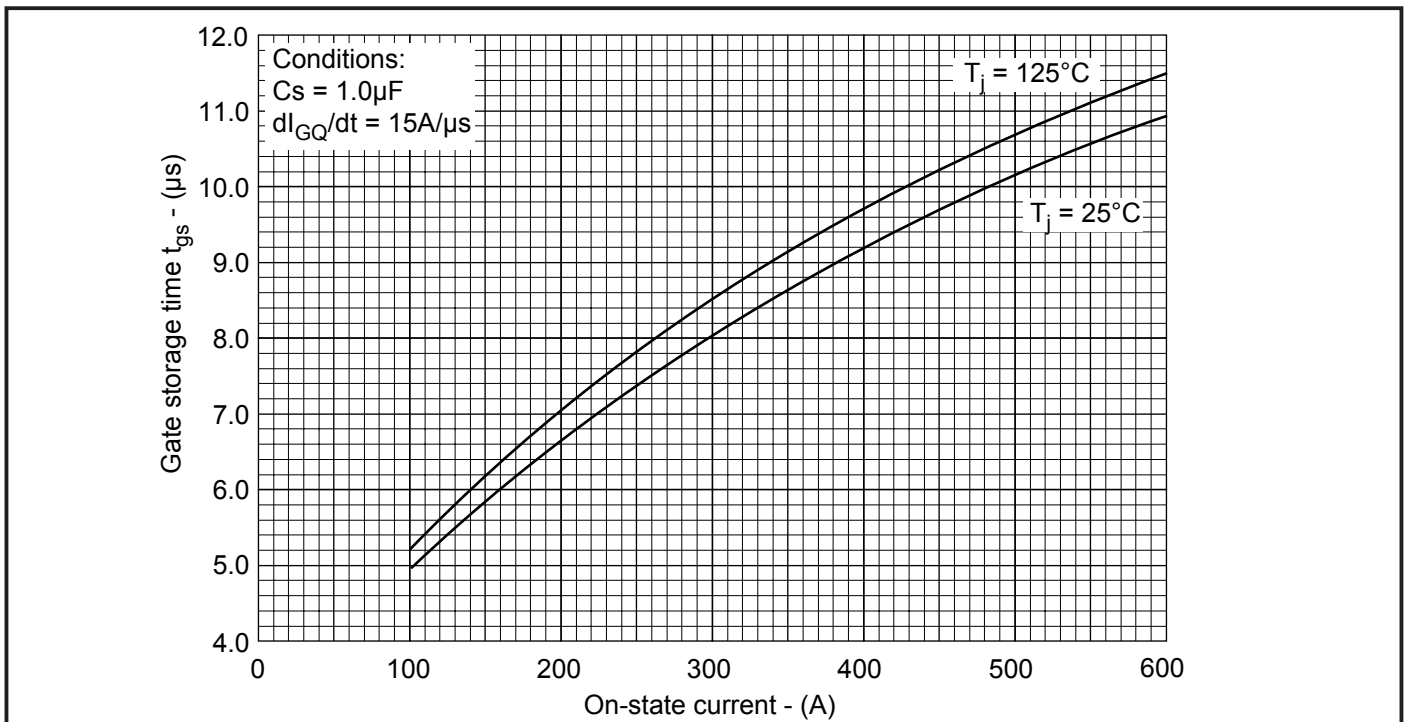

Fig.20 Gate storage time vs on-state current

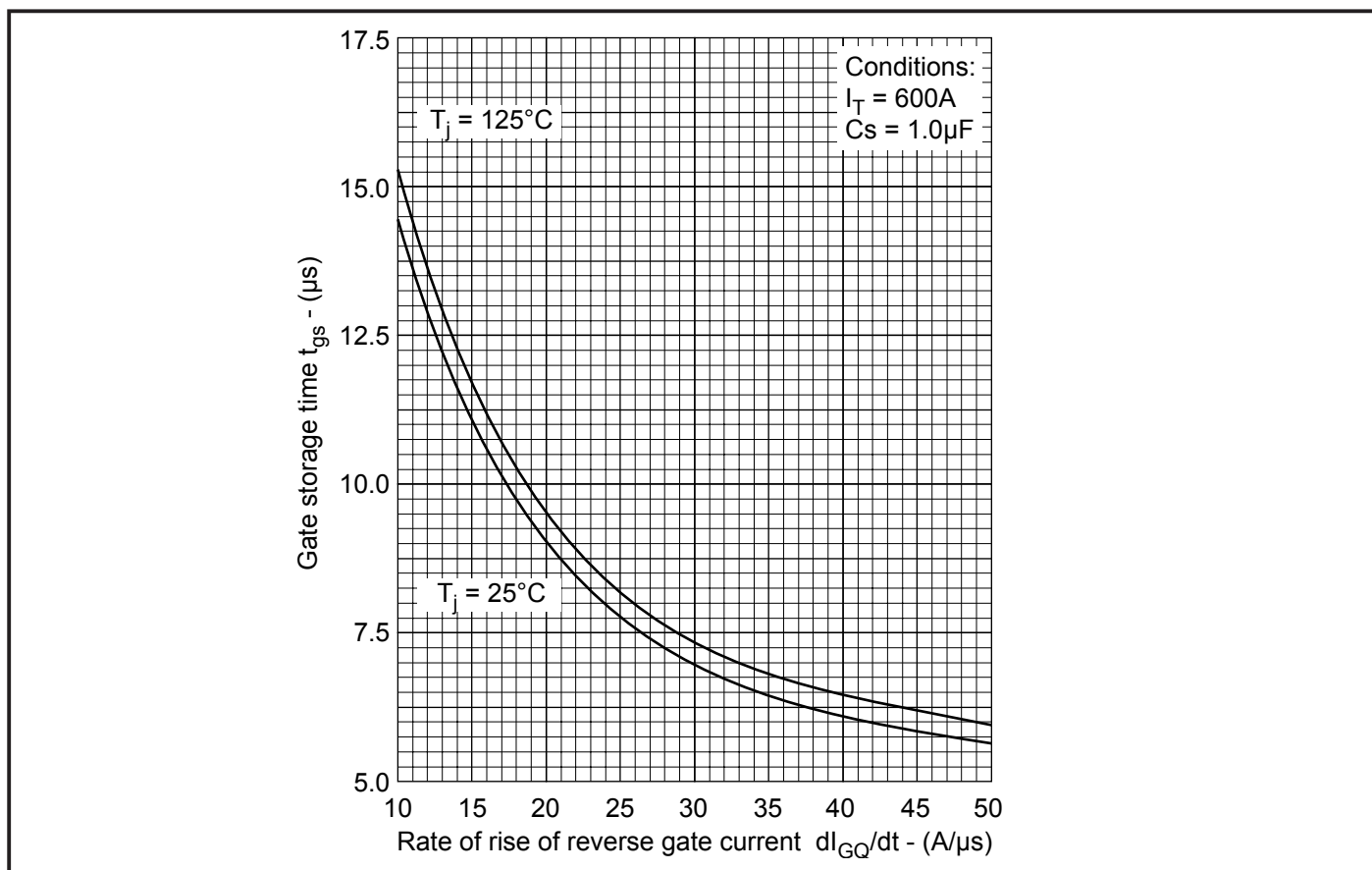

Fig.21 Gate storage time vs rate of rise of reverse gate current

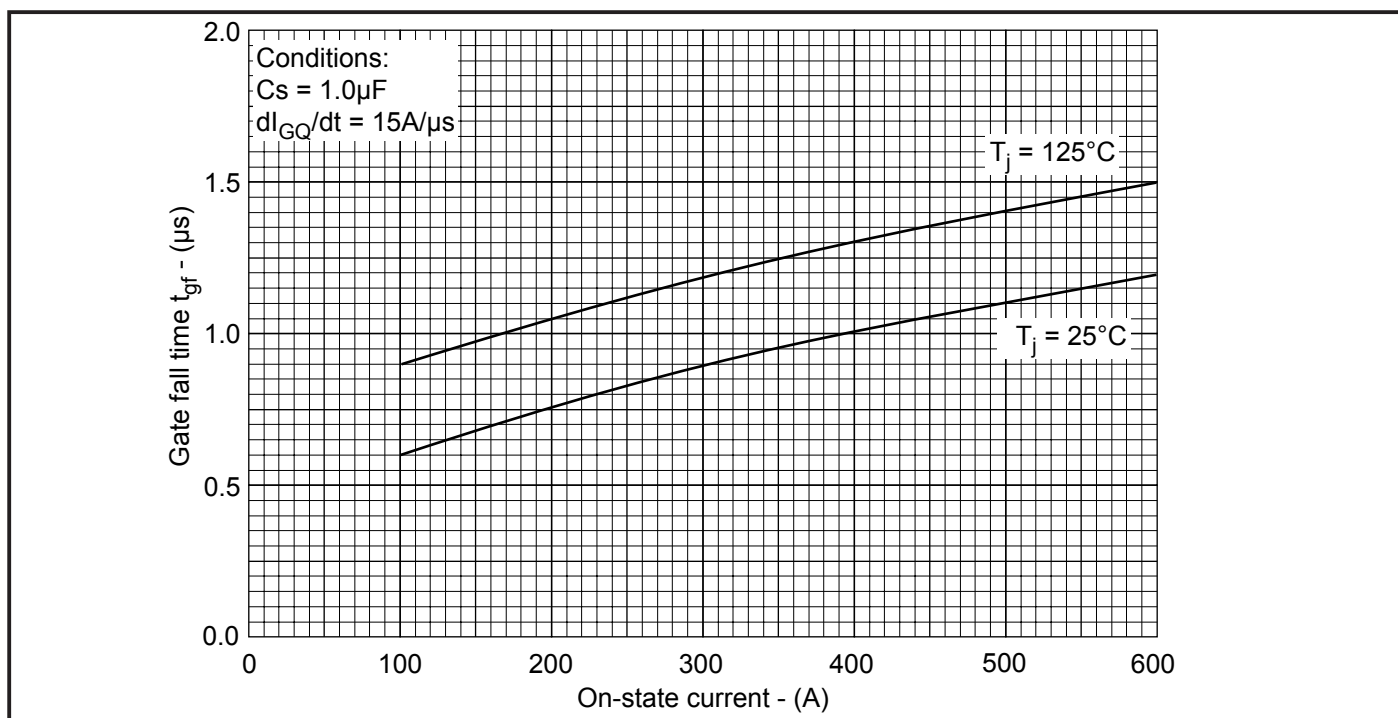

Fig.22 Gate fall time vs on-state current

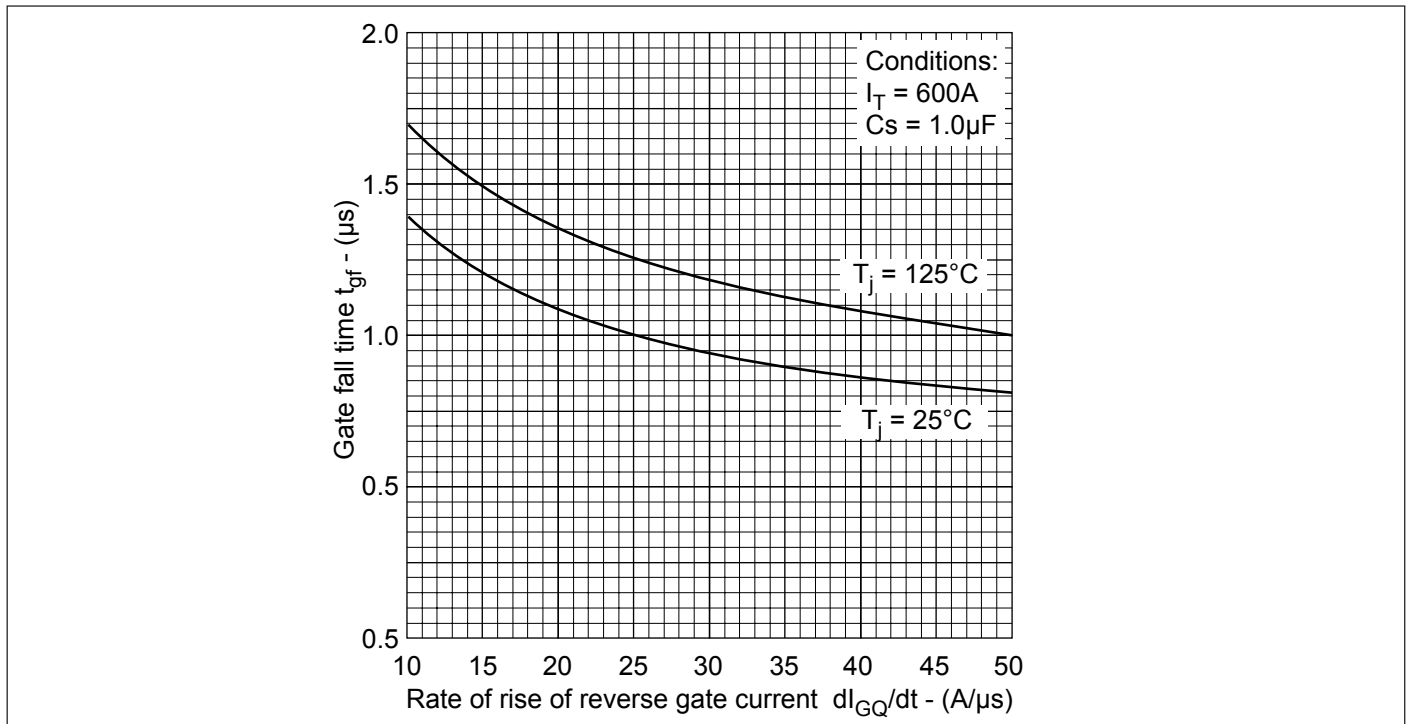

Fig.23 Gate fall time vs rate of rise of reverse gate current

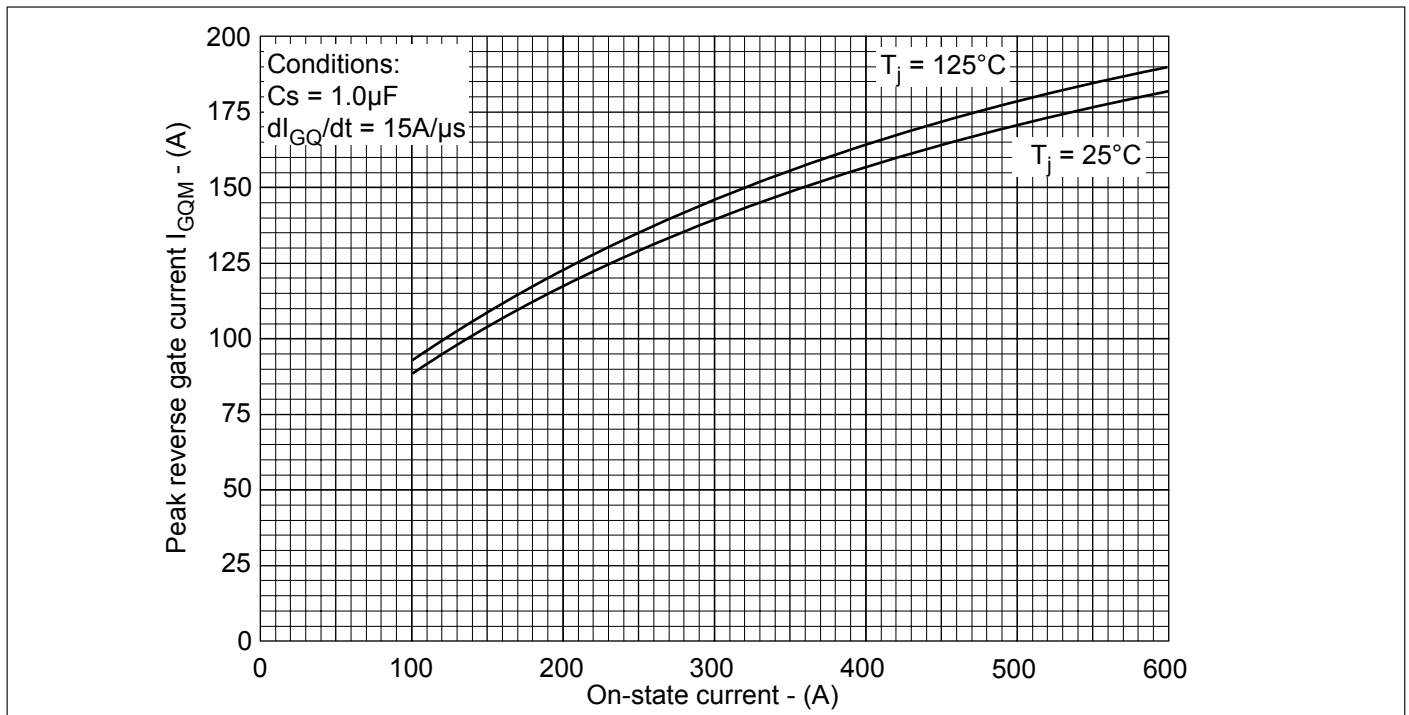

Fig.24 Peak reverse gate current vs on-state voltage

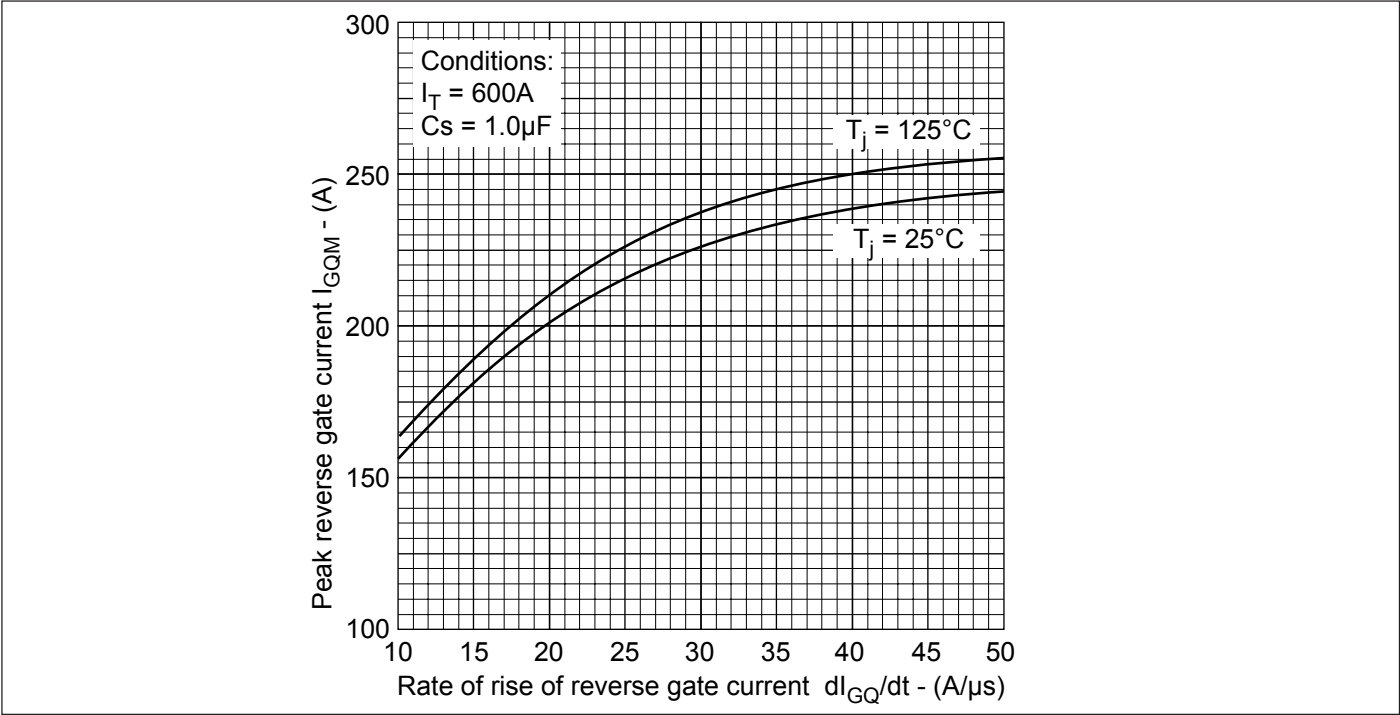

Fig.25 Reverse gate current vs rate of rise of reverse gate current

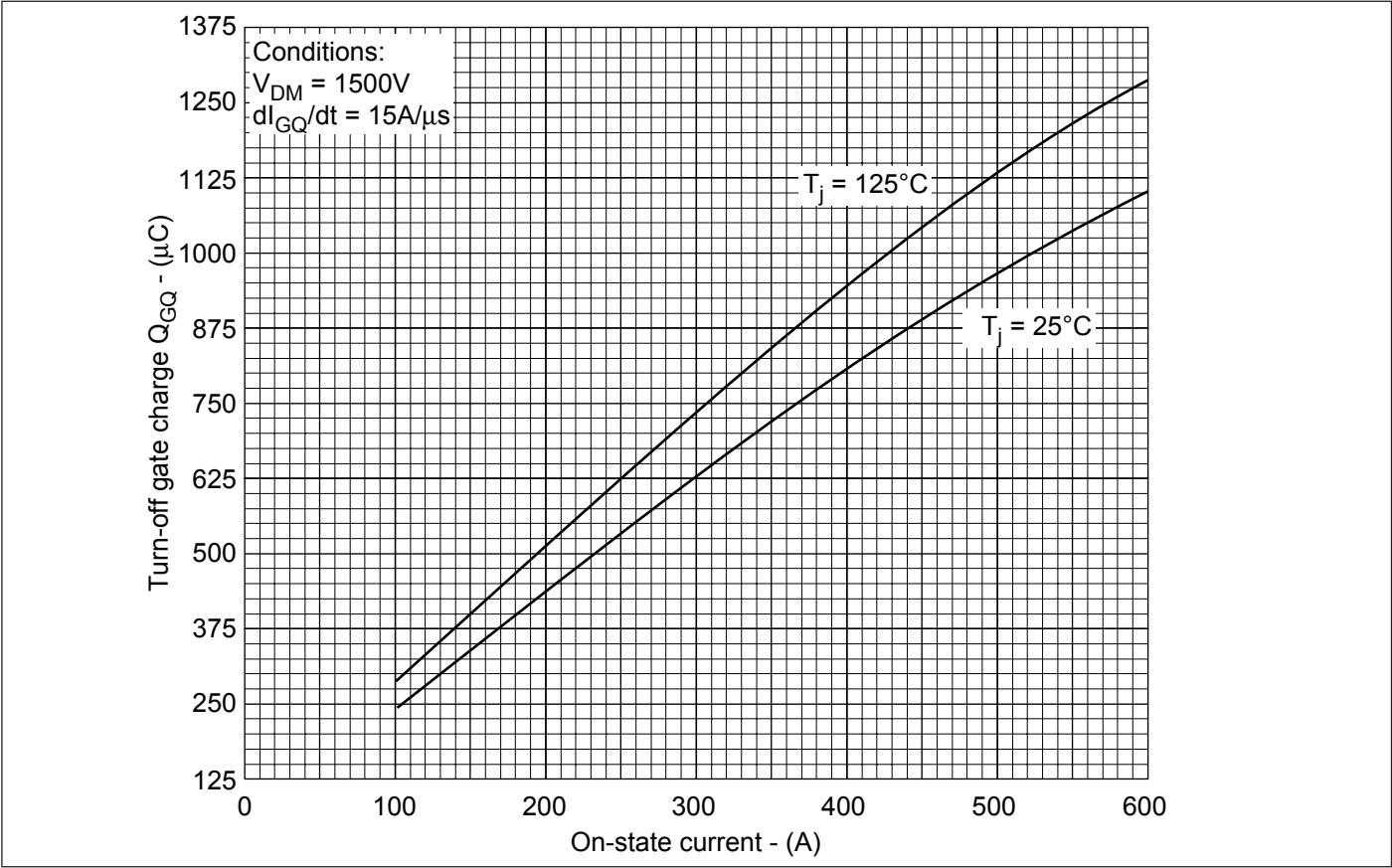

Fig.26 Turn-off gatecharge vs on-state voltage

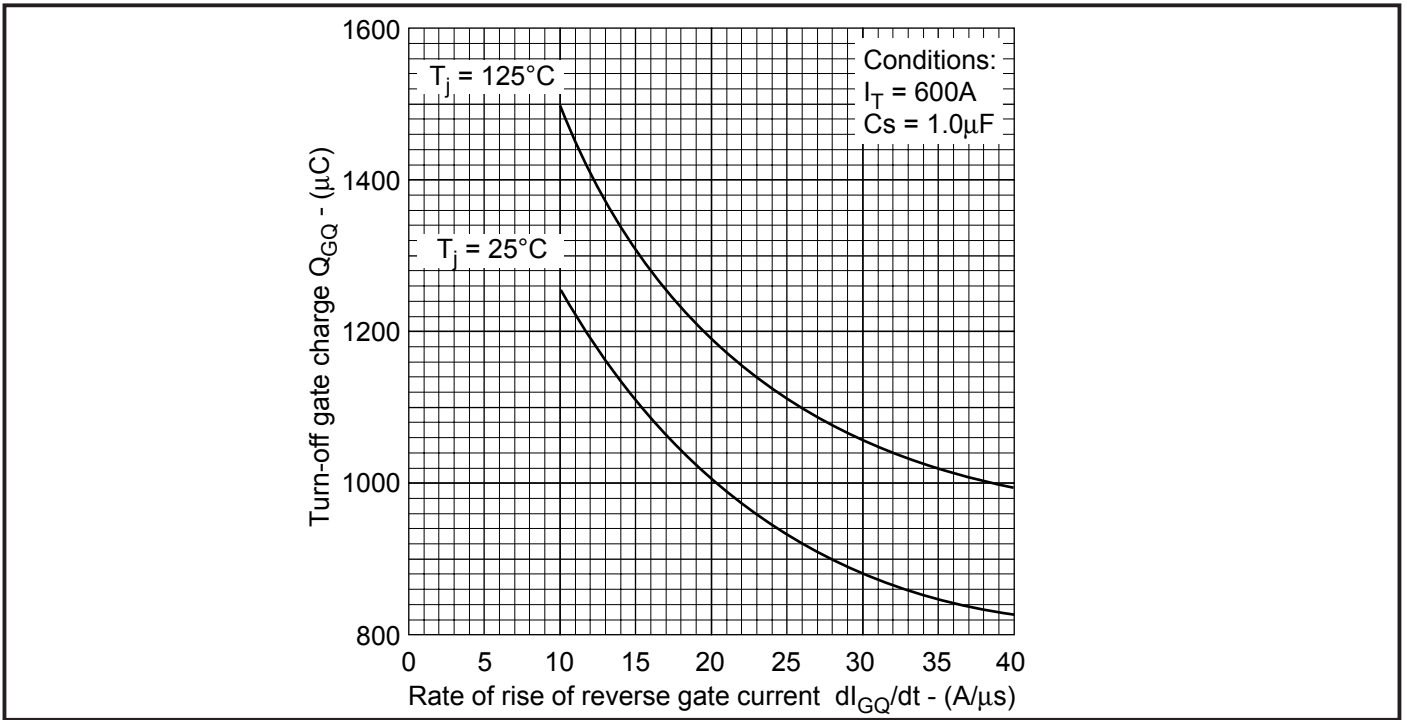

Fig.27 Turn-off gate charge vs rate of rise or reverse gate current

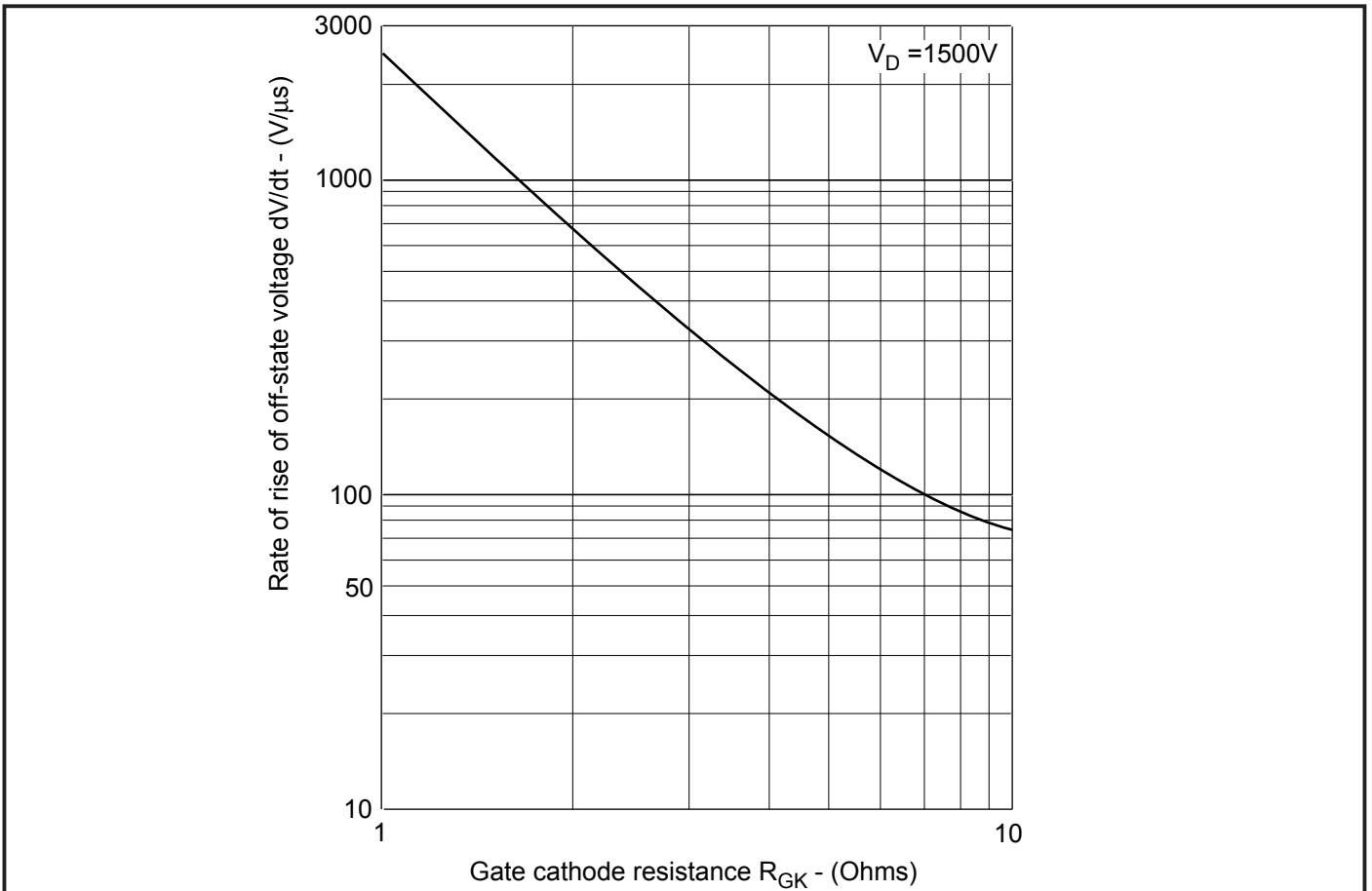
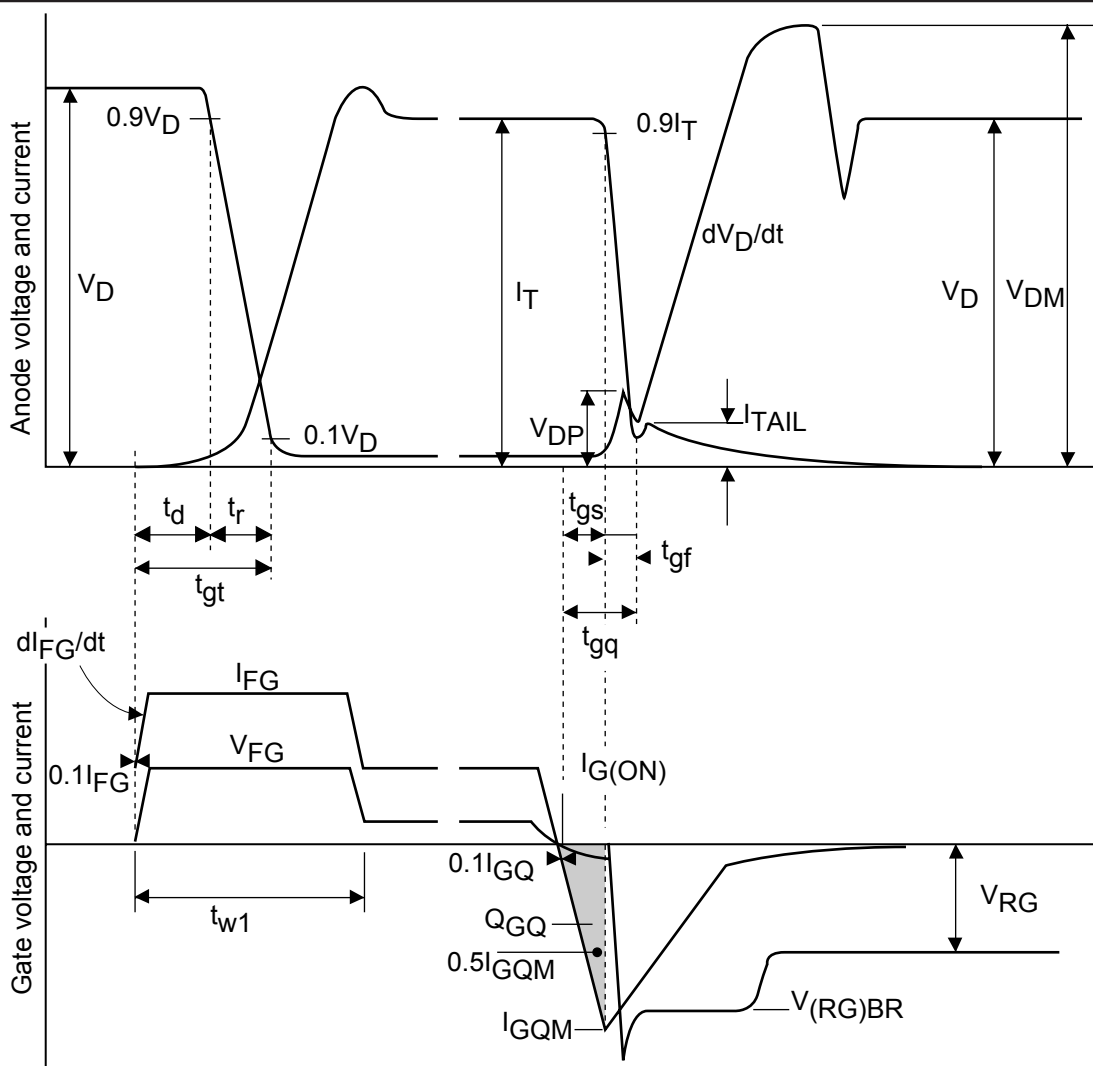

Fig.28 Typical rate of rise of off-state voltage vs gate cathode resistance



Recommended gate conditions:

- $I_{TCM} = 600A$
- $I_{FG} = 20A$
- $I_{G(ON)} = 2A$ d.c.
- $t_{w1(min)} = 10\mu s$
- $I_{GQM} = 190A$
- $di_{GQ}/dt = 15A/\mu s$
- $Q_{GQ} = 1300\mu C$
- $V_{RG(min)} = 2.0V$
- $V_{RG(max)} = 16V$

These are recommended Dynex Semiconductor conditions. Other conditions are permitted according to users gate drive specifications.

Fig.29 General switching waveforms

DG306AE25

PACKAGE DETAILS

For further package information, please contact your local Customer Service Centre. All dimensions in mm, unless stated otherwise. DO NOT SCALE.

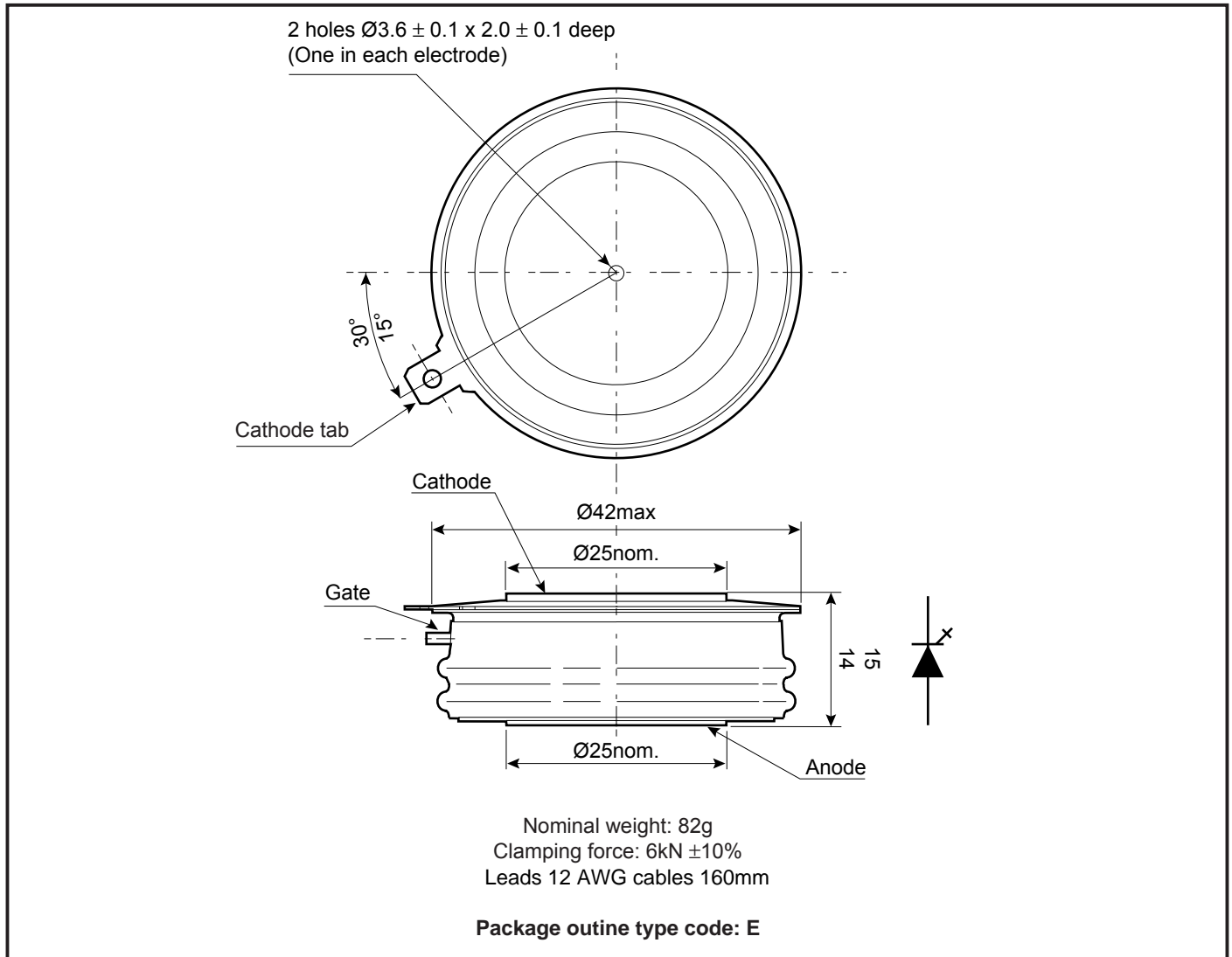

ASSOCIATED PUBLICATIONS

Title	Application Note Number
Calculating the junction temperature or power semiconductors	AN4506
GTO gate drive units	AN4571
Recommendations for clamping power semiconductors	AN4839
Use of V_{TO} , r_T on-state characteristic	AN5001
Improved gate drive for GTO series connections	AN5177



IMPORTANT INFORMATION:

This publication is provided for information only and not for resale.

The products and information in this publication are intended for use by appropriately trained technical personnel.

Due to the diversity of product applications, the information contained herein is provided as a general guide only and does not constitute any guarantee of suitability for use in a specific application. The user must evaluate the suitability of the product and the completeness of the product data for the application. The user is responsible for product selection and ensuring all safety and any warning requirements are met. Should additional product information be needed please contact Customer Service.

Although we have endeavoured to carefully compile the information in this publication it may contain inaccuracies or typographical errors. The information is provided without any warranty or guarantee of any kind.

This publication is an uncontrolled document and is subject to change without notice. When referring to it please ensure that it is the most up to date version and has not been superseded.

The products are not intended for use in applications where a failure or malfunction may cause loss of life, injury or damage to property. The user must ensure that appropriate safety precautions are taken to prevent or mitigate the consequences of a product failure or malfunction.

The products must not be touched when operating because there is a danger of electrocution or severe burning. Always use protective safety equipment such as appropriate shields for the product and wear safety glasses. Even when disconnected any electric charge remaining in the product must be discharged and allowed to cool before safe handling using protective gloves.

Extended exposure to conditions outside the product ratings may affect reliability leading to premature product failure. Use outside the product ratings is likely to cause permanent damage to the product. In extreme conditions, as with all semiconductors, this may include potentially hazardous rupture, a large current to flow or high voltage arcing, resulting in fire or explosion. Appropriate application design and safety precautions should always be followed to protect persons and property.

Product Status & Product Ordering:

We annotate datasheets in the top right hand corner of the front page, to indicate product status if it is not yet fully approved for production. The annotations are as follows:-

Target Information:	This is the most tentative form of information and represents a very preliminary specification. No actual design work on the product has been started.
Preliminary Information:	The product design is complete and final characterisation for volume production is in progress. The datasheet represents the product as it is now understood but details may change.
No Annotation:	The product has been approved for production and unless otherwise notified by Dynex any product ordered will be supplied to the current version of the data sheet prevailing at the time of our order acknowledgement.

All products and materials are sold and services provided subject to Dynex's conditions of sale, which are available on request.

Any brand names and product names used in this publication are trademarks, registered trademarks or trade names of their respective owners.

HEADQUARTERS OPERATIONS

DYNEX SEMICONDUCTOR LIMITED
Doddington Road, Lincoln, Lincolnshire, LN6 3LF
United Kingdom.
Phone: +44 (0) 1522 500500
Fax: +44 (0) 1522 500550
Web: <http://www.dynexsemi.com>

CUSTOMER SERVICE

Phone: +44 (0) 1522 502753 / 502901
Fax: +44 (0) 1522 500020
e-mail: power_solutions@dynexsemi.com