

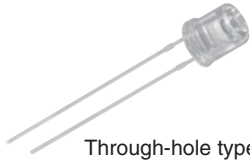

SMD type



Through-hole type



Chip type
(2.0 × 1.25 × 0.55 mm)
(.079 × .049 × .022 inch)

FEATURES

1. Built-in optical filter for spectral response similar to that of the human eye.
2. Photocurrent is proportional to illumination. (linear output)
3. Uses environmentally friendly silicon chips.

TYPICAL APPLICATIONS

SMD and Through-hole types

1. Brightness detection for LCD backlight control for LCD devices (LCD TVs, car navigation systems, and mobile PCs).
2. Brightness detection for circuits in residential lighting, lighting for security, and automatic lighting for bicycle.
3. Household appliances (day/night energy savings for air conditioners and electric hot water pots, etc.)
4. Brightness detection for wall clocks (radio clocks).

Chip type

1. Brightness detection for LCD backlight control for compact mobile devices (mobile phones and PDAs).
2. Brightness detection for controlling the keypad backlight in mobile phones.

Compliance with RoHS Directive

TYPES

Type (shape)	Photo current	Part No.	
		Tape and reel package	Baggage package
SMD type	260 μ A*	AMS104Y	—
Through-hole type		AMS302T	AMS302
Chip type	20 μ A*	AMS402Y	—

Standard packing: Tape and reel package SMD type: Carton: 3,000 pcs.; Case: 3,000 pcs.
 Tape and reel package Through-hole type: Carton: 2,000 pcs.; Case: 2,000 pcs.
 Baggage package Through-hole type: Carton: 500 pcs.; Case: 1,000 pcs.
 Tape and reel package Chip type: Carton: 3,000 pcs.; Case: 3,000 pcs.

Notes: *Ev = 100 lx (Ev: Brightness, Fluorescent lamp is used as light source)
 Tape and reel package is standard packaging style for SMD and chip types. ("Y" and "T" at end of part number indicate packaging type.)

RATINGS

1. Absolute maximum ratings (Measuring condition: ambient temperature: 25°C 77°F)

Item	Symbol	AMS104/AMS302	AMS402	Remarks
Reverse voltage	V_R	-0.5 to 8 V	-0.5 to 6 V	—
Photocurrent	I_L	5 mA	1 mA	—
Power dissipation	P	40 mW	6 mW	—
Operating temperature	T_{opr}	-30 to +85°C -22 to +185°F	-30 to +85°C -22 to +185°F	Non-condensing at low temperatures
Storage temperature	T_{stg}	-40 to +100°C -40 to +176°F	-40 to +100°C -40 to +176°F	Non-condensing at low temperatures

2. Recommended operating condition

Item	Symbol	AMS104/AMS302	AMS402	Remarks
Reverse voltage	Minimum	1.5 V	1.5 V	—
	Maximum	6 V	5.5 V	

Light Sensor (AMS1, 3, 4)

3. Electrical and optical characteristics (Measuring condition: ambient temperature: 25°C 77°F)

Item	Symbol	AMS104/AMS302	AMS402	Condition	
Peak sensitivity wavelength	λ_p	580 nm	560 nm	—	
Photocurrent 1	Minimum	9.1 μA	0.7 μA	AMS104/AMS302: $V_R = 5\text{ V}$, $E_V = 5\text{ lx}^*1$ AMS402: $V_R = 3\text{ V}$, $E_V = 5\text{ lx}^*1$	
	Typical	13 μA	1 μA		
	Maximum	16.9 μA	1.3 μA		
Photocurrent 2	Minimum	182 μA	14 μA	AMS104/AMS302: $V_R = 5\text{ V}$, $E_V = 100\text{ lx}^*2$ AMS402: $V_R = 3\text{ V}$, $E_V = 100\text{ lx}^*2$	
	Typical	260 μA	20 μA		
	Maximum	338 μA	26 μA		
Photocurrent 3	Typical	500 μA	35 μA	AMS104/AMS302: $V_R = 5\text{ V}$, $E_V = 100\text{ lx}^*2$ AMS402: $V_R = 3\text{ V}$, $E_V = 100\text{ lx}^*2$	
Dark current	Maximum	0.3 μA	0.05 μA	AMS104/AMS302: $V_R = 5\text{ V}$, $E_V = 0\text{ lx}$ AMS402: $V_R = 3\text{ V}$, $E_V = 0\text{ lx}$	
Switching time	Rise time	Typical	8.5 ms	1.2 ms	AMS104/AMS302: $V_{CC} = 5.0\text{ V}$, $V_O = 2.5\text{ V}$, $R_L = 5\text{ k}\Omega$ AMS104/AMS302: $V_{CC} = 3.0\text{ V}$, $V_O = 1.5\text{ V}$, $R_L = 5\text{ k}\Omega$
	Fall time	Typical	8.5 ms	1.2 ms	

Notes: *1. Fluorescent lamp is used as light source. E_V = Brightness
*2. CIE standard illuminant 'A' is used as light source.
*3. Measuring method for switching time.

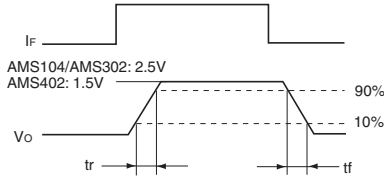
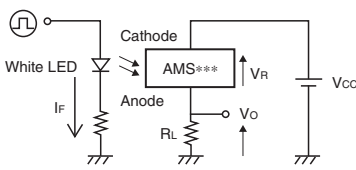

REFERENCE DATA

1. Power dissipation vs. ambient temperature characteristics

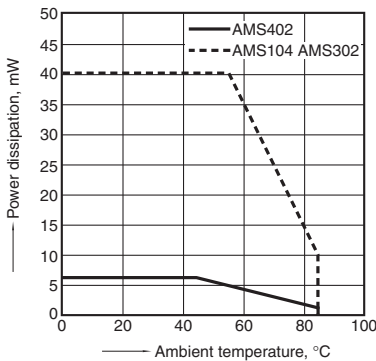

2. Relative sensitivity vs. wavelength characteristics
Reverse voltage: 3V (AMS402), 5V (AMS104, AMS302)
Ambient temperature: 25°C 77°F

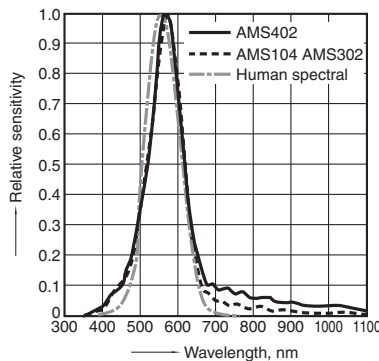

3. Dark current vs. ambient temperature characteristics
Reverse voltage: 3V (AMS402), 5V (AMS104, AMS302)

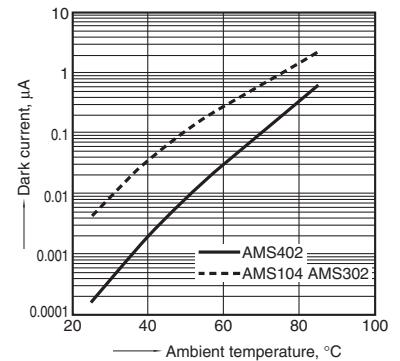

4. Photocurrent vs. brightness characteristics

Light source: Fluorescent lamp
Reverse voltage: 3V (AMS402), 5V (AMS104, AMS302)
Ambient temperature: 25°C 77°F

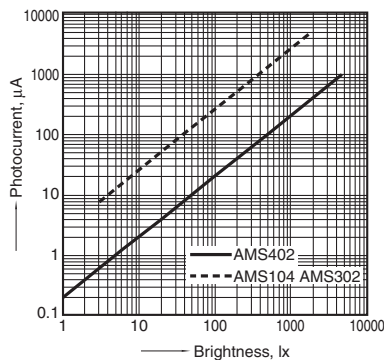

5. Relative photocurrent vs. ambient temperature characteristics

Light source: Fluorescent lamp, Brightness: 100 lx
Reverse voltage: 3V (AMS402), 5V (AMS104, AMS302)

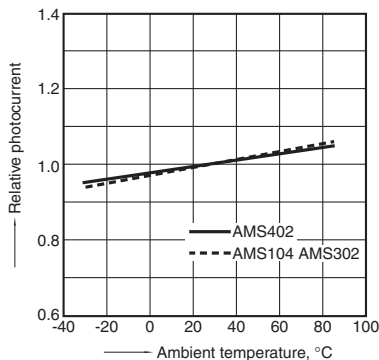

6. Relative photocurrent vs. reverse voltage characteristics

Light source: Fluorescent lamp, Brightness: 100 lx
Ambient temperature: 25°C 77°F

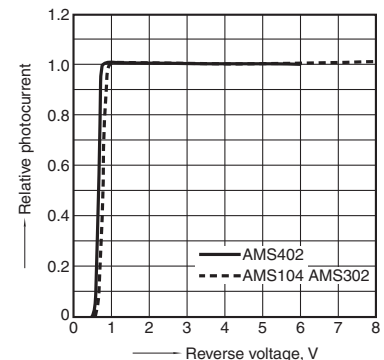

7. Switching time vs. resistive load characteristics

Light source: White LED
 Power voltage: 3V (AMS402), 5V (AMS104, AMS302)
 Resistive load voltage: 1.5V (AMS402),
 2.5V (AMS104, AMS302)
 Ambient temperature: 25°C 77°F

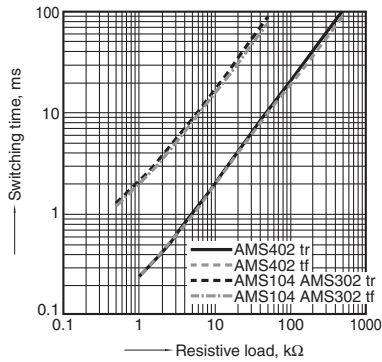

DIMENSIONS (mm inch)

The CAD data of the products with a **CAD Data** mark can be downloaded from: <http://panasonic-electric-works.net/ac>

1. SMD type

CAD Data

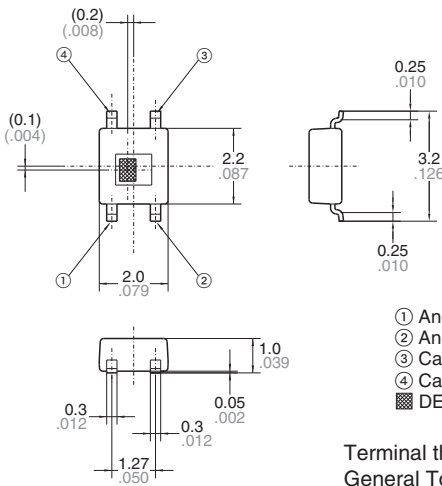
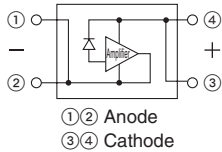

Recommended mounting pad
 (Top view)

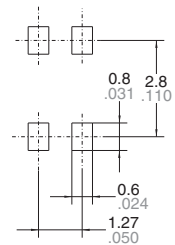

2. Through-hole type

CAD Data

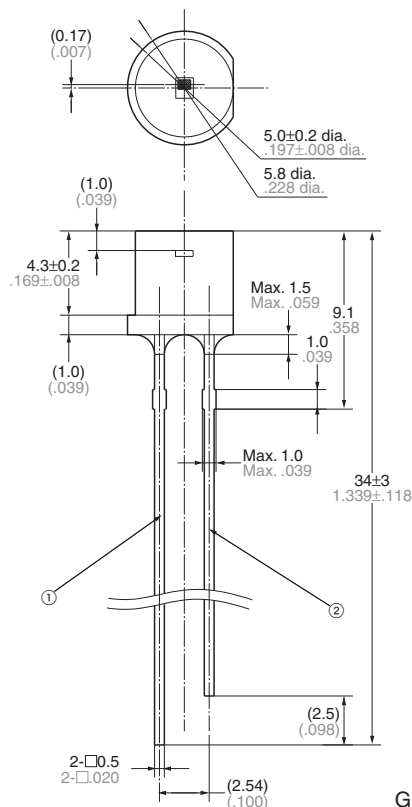
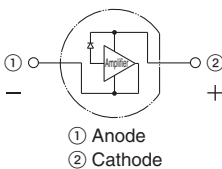
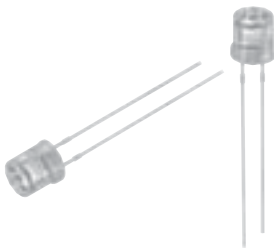

Light Sensor (AMS1, 3, 4)

3. Chip type

CAD Data

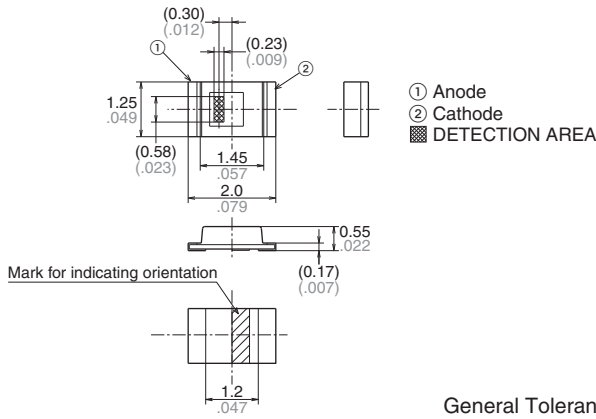
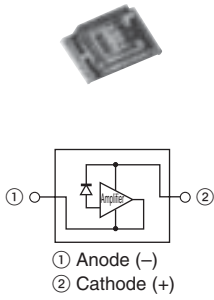

Recommended mounting pad (Top view)

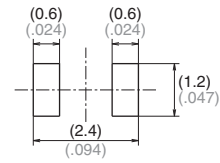

General Tolerance: $\pm 0.1 \pm .004$

SAFETY PRECAUTIONS

Be sure to obey the following in order to prevent injuries and accidents.

- Do not use the sensors under conditions that exceed the range of its specifications. It may cause overheating, smoke, or fire.

- Connect terminals correctly by verifying the pin layout with the specifications diagram or other instructions. Erroneous connections may lead to unexpected operating errors, overheating, smoke, or fire.

- For an important and serious application in terms of safety, add protection circuit or any other protection method.

CAUTIONS FOR USE

1. Applying stress that exceeds the absolute maximum rating

If the voltage or current value for any of the terminals exceeds the absolute maximum rating, internal elements will deteriorate because of the excessive voltage or current. In extreme cases, wiring may melt, or silicon P/N junctions may be destroyed.

Therefore the design should ensure that the absolute maximum ratings will never be exceeded, even momentarily.

2. Deterioration and destruction caused by discharge of static electricity

This phenomenon is generally called static electricity destruction. Static electricity generated by various factors flows through the terminal and occurs to destroy internal elements. To prevent problems from static electricity, the following precautions and measures should be taken when using your device.

- 1) Person handling sensor should wear anti-static clothing and should be grounded through protective resistance of 500 k Ω to 1 M Ω .
- 2) A conductive metal sheet should be placed over the work table. Measuring instruments and jigs should be grounded.
- 3) When using soldering irons, either use irons with low leakage current, or ground the tip of the soldering iron. (Use of low-voltage soldering irons is also recommended.)

4) Devices and equipment used in assembly should also be grounded.

5) When packing printed circuit boards and equipment, avoid using high-polymer materials such as foam styrene, plastic, and other materials which carry an electrostatic charge.

6) When storing or transporting sensor, the environment should not be generated static electricity (for instance, the humidity should be between 45 and 60%), and sensor should be protected using conductive packing materials.

3. Just after supplying voltage, please note that current in the sensor will be not constant until internal circuit stability.

4. Storage

The sensors are transparent plastic packages. They are sensitive to moisture and come in moisture-proof packages. Observe the following cautions when storing.

- 1) After the moisture-proof package is unsealed, take the sensors out of storage as soon as possible (within 1 week \leq 30°C 86°F/60% R.H.).
- 2) If the devices are to be left in storage for a considerable period after the moisture-proof package has been unsealed, it is recommended to keep them in another moisture-proof bag containing silica gel (within 3 months at the most).

3) Storage under extreme conditions will cause soldering degradation, external appearance defects, and deterioration of the characteristics. The following storage conditions are recommended:

- Temperature: 0 to 30°C 32 to 86°F
- Humidity: Less than 60% R.H. (Avoid freezing and condensing)
- Atmosphere: No harmful gasses such as sulfurous acid gas, minimal dust.

*When mounting with solder, if thermal stress is applied to sensors that have absorbed moisture, the moisture will vaporize, swelling will occur, and the inside of the package will become stressed. This may cause the package surface to blister or crack. Therefore, please take caution and observe the soldering conditions in the following section.

5. Recommended soldering conditions

<SMD/Chip type>

1) Recommended condition

(1) IR (Infrared reflow) soldering method

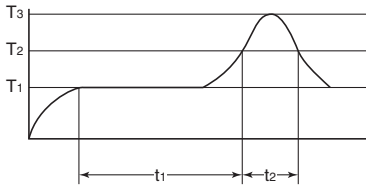

$T_1 = 150 \text{ to } 180^\circ\text{C } 302 \text{ to } 356^\circ\text{F}$

$T_2 = 230^\circ\text{C } 446^\circ\text{F}$

$T_3 = 250^\circ\text{C } 482^\circ\text{F}$ or less

$t_1 = 60 \text{ to } 120 \text{ s}$ or less

$t_2 = 30 \text{ s}$ or less

(2) Soldering iron method

Tip temperature: $350 \text{ to } 400^\circ\text{C } 662 \text{ to } 752^\circ\text{F}$

Wattage: 30 to 60 W

Soldering time: within 3 s

*We don't recommend soldering iron method for chip type.

2) Do not do flow soldering.

<Through-hole type>

1) Recommended condition

(1) Double wave soldering method

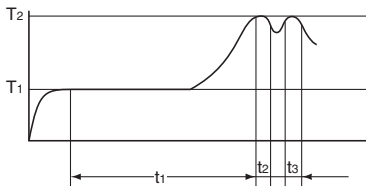

$T_1 = 120^\circ\text{C } 248^\circ\text{F}$

$T_2 = 260^\circ\text{C } 500^\circ\text{F}$ or less

$t_1 = 120 \text{ s}$ or less

$t_2 + t_3 = 6 \text{ s}$ or less

(2) Soldering iron method

Tip temperature: $350 \text{ to } 400^\circ\text{C } 662 \text{ to } 752^\circ\text{F}$

Wattage: 30 to 60 W

Soldering time: within 3 s

2) The soldered position on leads should not be closer than 3mm .118inch to the molding resin of this sensor.

6. Notes for mounting

1) Temperature rise in the lead portion is highly dependent on package size.

If multiple different packages are mounted on the same board, please check your board beforehand in an actual product, ensuring that the temperature of the solder area of the sensor terminals falls within the temperature conditions of item 5.

2) If the mounting conditions exceed the recommended solder conditions in item 5, resin strength will fall and the mismatching of the heat expansion coefficient of each constituent material will increase markedly, possibly causing cracks in the package, disconnections of bonding wires, and the like. For this reason, please inquire with us about whether this use is possible.

7. Cleaning solvents compatibility

We recommend dip cleaning with an organic solvent for removal of solder flux etc. If you cannot avoid using ultrasonic cleansing, please ensure that the following conditions are met, and check beforehand for defects.

- Frequency: 27 to 29 kHz
- Ultrasonic power: No greater than $0.25\text{W}/\text{cm}^2$
- Cleaning time: No longer than 30 s
- Cleanser used: Asahiklin AK-225
- Other:

Submerge in solvent in order to prevent the PCB and sensors from being contacted directly by the ultrasonic vibrations.

Note: Applies to unit area ultrasonic power for ultrasonic baths.

8. Transportation

Extreme vibration during transport will warp the lead or damage the sensor. Handle the outer and inner boxes with care.

9. Avoid using the sensor in environments containing excessive amounts of steam, dust, corrosive gas, or where organic solvents are present.

10. Lead forming and cutting of through-hole type

1) Lead forming must be done at normal temperature before soldering

2) The bent and cut position on leads should not be closer than 3mm .118inch to the base of leads.

3) Lead forming and cutting must be done while fixing the base of leads.

4) Avoid mounting with stress at the base of leads.

11. The following shows the packaging format

1) SMD type tape and reel (mm inch)

Type	Tape dimensions	Dimensions of tape reel
Light sensor NaPiCa SMD type AMS104Y	<p>Note) When picked from 1 and 4-pin side (Please inquire for tape and reel packaging with 2-pin and 3-pin on the pull-out side.)</p>	

Light Sensor (AMS1, 3, 4)

2) Through-hole type tape and reel (mm inch)

Type	Tape dimensions	Symbol	Symbol	Dimensions	Remarks
Acceleration sensors Light sensors NaPiCa Through-hole type AMS302T		Feed hole pitch	P ₀	12.7±0.3 .500±.012	
		Product interval pitch	P	12.7±1.0 .500±.039	
		Product distance	P ₂	6.35±1.3 .250±.051	
		Product bottom distance	H	20.5±1.0 .807±.039	
		Lead interval	F	2.54±0.5 .100±.020	
		Product slant	Δh	0±1.0 0±.039	
		Product tilt	Δp	0±1.0 0±.039	
		Tape width	W	18.0 ^{+1.0} _{-0.5} .709 ^{+0.039} _{-.020}	
		Holding tape width	W ₀	13.0±0.3 .512±.012	
		Feed hole position	W ₁	9.0 ^{-0.75} _{-0.5} .354 ^{+0.030} _{-.020}	
		Holding tape distance	W ₂	0 to 0.5 0 to .020	
		Feed hole diameter	D ₀	3.8±0.2 .150±.008	
		Tape thickness	t	0.5±0.2 .020±.008	Included holding tape thickness
		Defective product cutoff position	L	Max.: 11.0 .433	

3) Chip type tape and reel (mm inch)

Type	Tape dimensions	Dimensions of tape reel
Pressure sensors Light sensor NaPiCa Chip type AMS402Y		

Light Sensor NaPiCa terminology

Term	Symbol	Explanation
Reverse voltage	V _R	The applied voltage between the cathode and anode.
Photocurrent	I _L	The current that flows between the cathode and anode when light is applied.
Power dissipation	P	The electric power loss that occurs between the cathode and anode.
Operating temperature	T _{opr}	The workable ambient temperature range at which normal operation is possible under the condition of a prescribed allowable loss.
Storage temperature	T _{stg}	The ambient temperature range at which the sensor can be left or stored without applying voltage.
Peak sensitivity wavelength	λ _p	The wavelength of light at which sensitivity is at its maximum.
Dark current	I ₀	The current between the cathode and anode when reverse voltage is applied during darkness.
Rise time	t _r	Time required for the output waveform to rise from 10% to 90% when light is applied.
Fall time	t _f	Time required for the output waveform to fall from 90% to 10% when light is cut.