

**Leading the market,
our 5 mm 2-pole surface
mount relays comply with
JIS C0806**

TQ RELAYS

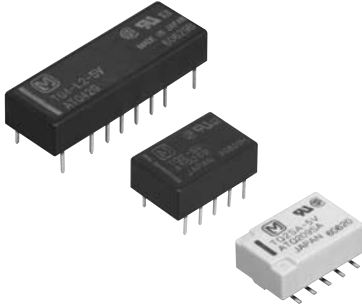

By using the highly efficient polar magnetic circuit “seesaw balance mechanism”, a nominal operating power of 140 mW (minimum operating power of 79 mW) has been achieved (4 Form C single side stable type is 280 mW).

- 3. Suitable for SMD automatic insertion (SA type)**
With a height of 5.6 mm .220 inch, the relays meet JIS C 0806 specifications.
- 4. High density mounting possible**
High-efficiency magnetic circuits ensure low magnetic flux leakage. Because characteristics are little changed by proximity mounting, high-density mounting is possible.
- 5. The use of gold-clad twin crossbar contacts ensures high contact reliability.**
- 6. DIL terminal array enables use of IC sockets.**
- 7. Low thermal electromotive force**
As well as low power consumption of 140 mW, use of a structure with separate coil and contact sections has reduced thermal electromotive force to the low level of approximately 5 μ V. Surface mount types achieve approximately 2 μ V.

- 8. Latching types also available**
- 9. Self-clinching terminal also available**
- 10. A range of surface-mount types also available**
SA: Low-profile surface-mount terminal type
SL: High connection reliability surface-mount terminal type
SS: Space saving surface-mount terminal type
- 11. M.B.B. contact types available**

FEATURES

- 1. Flat compact size**
14.0(L) \times 9.0(W) \times 5.0(H) .551(L) \times .354(W) \times .197(H)
- 2. Nominal operating power:**
High sensitivity of 140mW (2 Form C single side stable type)

ORDERING INFORMATION

Contact arrangement

- 2: 2 Form C
- 4: 4 Form C

Terminal shape

- Nil: Standard PC board terminal
- H: Self-clinching terminal
- SA: SA type
- SL: SL type
- SS: SS type

Operating function

- Nil: Single side stable
- L: 1 coil latching
- L2: 2 coil latching

MBB function

- Nil: Standard (B.B.M.) type
- 2M: 2M.B.B. type

Nominal coil voltage (DC)*

- 1.5 (SMD only), 3, 4.5, 5, 6, 9, 12, 24, 48V

Packing style

- Nil: Tube packing
- X: Tape and reel (picked from 1/2/3/4/5-pin side)
- Z: Tape and reel packing (picked from the 6/7/8/9/10-pin side)

Notes: 1. *48 V coil type: Single side stable only

2. In case of 5 V transistor drive circuit, it is recommended to use 4.5 V type relay.

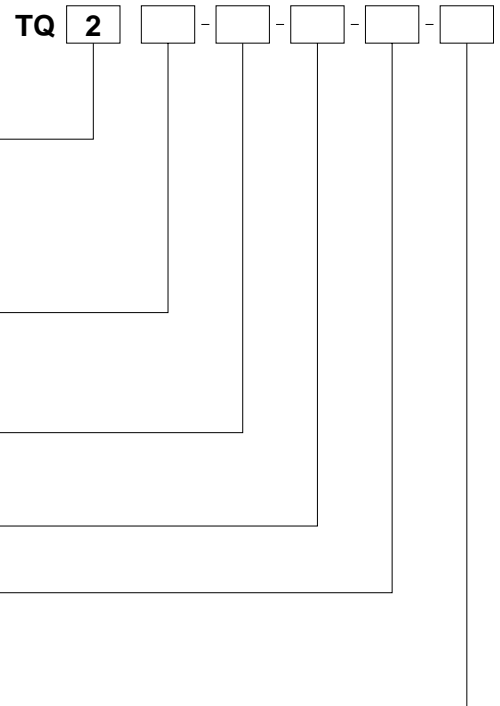

TYPES

■ Standard PC board terminal and self-clinching terminal

1. Standard (B.B.M.) type

1) Standard PC board terminal

Contact arrangement	Nominal coil voltage	Single side stable	1 coil latching	2 coil latching
		Part No.	Part No.	Part No.
2 Form C	3V DC	TQ2-3V	TQ2-L-3V	TQ2-L2-3V
	4.5V DC	TQ2-4.5V	TQ2-L-4.5V	TQ2-L2-4.5V
	5V DC	TQ2-5V	TQ2-L-5V	TQ2-L2-5V
	6V DC	TQ2-6V	TQ2-L-6V	TQ2-L2-6V
	9V DC	TQ2-9V	TQ2-L-9V	TQ2-L2-9V
	12V DC	TQ2-12V	TQ2-L-12V	TQ2-L2-12V
	24V DC	TQ2-24V	TQ2-L-24V	TQ2-L2-24V
	48V DC	TQ2-48V	—	—
4 Form C	3V DC	TQ4-3V	TQ4-L-3V	TQ4-L2-3V
	4.5V DC	TQ4-4.5V	TQ4-L-4.5V	TQ4-L2-4.5V
	5V DC	TQ4-5V	TQ4-L-5V	TQ4-L2-5V
	6V DC	TQ4-6V	TQ4-L-6V	TQ4-L2-6V
	9V DC	TQ4-9V	TQ4-L-9V	TQ4-L2-9V
	12V DC	TQ4-12V	TQ4-L-12V	TQ4-L2-12V
	24V DC	TQ4-24V	TQ4-L-24V	TQ4-L2-24V
	48V DC	TQ4-48V	—	—

Standard packing (2 Form C): Tube: 50 pcs.; Case: 1,000 pcs.

Standard packing (4 Form C): Tube: 25 pcs.; Case: 500 pcs.

2) Self-clinching terminal

Contact arrangement	Nominal coil voltage	Single side stable	1 coil latching	2 coil latching
		Part No.	Part No.	Part No.
2 Form C	3V DC	TQ2H-3V	TQ2H-L-3V	TQ2H-L2-3V
	4.5V DC	TQ2H-4.5V	TQ2H-L-4.5V	TQ2H-L2-4.5V
	5V DC	TQ2H-5V	TQ2H-L-5V	TQ2H-L2-5V
	6V DC	TQ2H-6V	TQ2H-L-6V	TQ2H-L2-6V
	9V DC	TQ2H-9V	TQ2H-L-9V	TQ2H-L2-9V
	12V DC	TQ2H-12V	TQ2H-L-12V	TQ2H-L2-12V
	24V DC	TQ2H-24V	TQ2H-L-24V	TQ2H-L2-24V
	48V DC	TQ2H-48V	—	—
4 Form C	3V DC	TQ4H-3V	TQ4H-L-3V	TQ4H-L2-3V
	4.5V DC	TQ4H-4.5V	TQ4H-L-4.5V	TQ4H-L2-4.5V
	5V DC	TQ4H-5V	TQ4H-L-5V	TQ4H-L2-5V
	6V DC	TQ4H-6V	TQ4H-L-6V	TQ4H-L2-6V
	9V DC	TQ4H-9V	TQ4H-L-9V	TQ4H-L2-9V
	12V DC	TQ4H-12V	TQ4H-L-12V	TQ4H-L2-12V
	24V DC	TQ4H-24V	TQ4H-L-24V	TQ4H-L2-24V
	48V DC	TQ4H-48V	—	—

Note: Types ("3" to the end of part No.) designed to withstand strong vibration caused, for example, by the use of terminal cutters, can also be ordered. However, please contact us if you need parts for use in low level load.

2. M.B.B. type

1) Standard PC board terminal

Contact arrangement	Nominal coil voltage	Single side stable
		Part No.
2 Form C	3V DC	TQ2-2M-3V
	4.5V DC	TQ2-2M-4.5V
	5V DC	TQ2-2M-5V
	6V DC	TQ2-2M-6V
	9V DC	TQ2-2M-9V
	12V DC	TQ2-2M-12V
	24V DC	TQ2-2M-24V

Standard packing: Tube: 50 pcs.; Case: 1,000 pcs.

2) Self-clinching terminal

Contact arrangement	Nominal coil voltage	Single side stable
		Part No.
2 Form C	3V DC	TQ2H-2M-3V
	4.5V DC	TQ2H-2M-4.5V
	5V DC	TQ2H-2M-5V
	6V DC	TQ2H-2M-6V
	9V DC	TQ2H-2M-9V
	12V DC	TQ2H-2M-12V
	24V DC	TQ2H-2M-24V

Standard packing: Tube: 50 pcs.; Case: 1,000 pcs.

Notes: 1. Latching types are available by request. Please consult us for details.

2. UL/CSA approved (UL file No.:E 43149, CSA file No.: LR26550)

3. Types ("1" to the end of part No.) designed to withstand strong vibration caused, for example, by the use of terminal cutters, can also be ordered. However, please contact us if you need parts for use in low level load and low thermal power.

■ Surface-mount terminal

1) Tube packing

Contact arrangement	Nominal coil voltage	Single side stable	1 coil latching	2 coil latching
		Part No.	Part No.	Part No.
2c	1.5V DC	TQ2S□-1.5V	TQ2S□-L-1.5V	TQ2S□-L2-1.5V
	3V DC	TQ2S□-3V	TQ2S□-L-3V	TQ2S□-L2-3V
	4.5V DC	TQ2S□-4.5V	TQ2S□-L-4.5V	TQ2S□-L2-4.5V
	5V DC	TQ2S□-5V	TQ2S□-L-5V	TQ2S□-L2-5V
	6V DC	TQ2S□-6V	TQ2S□-L-6V	TQ2S□-L2-6V
	9V DC	TQ2S□-9V	TQ2S□-L-9V	TQ2S□-L2-9V
	12V DC	TQ2S□-12V	TQ2S□-L-12V	TQ2S□-L2-12V
	24V DC	TQ2S□-24V	TQ2S□-L-24V	TQ2S□-L2-24V
	48V DC	TQ2S□-48V	—	—

□: For each surface-mounted terminal identification, input the following letter. SA type: A, SL type: L, SS type: S

Standard packing: Tube: 50 pcs.; Case: 1,000 pcs.

2) Tape and reel packing

Contact arrangement	Nominal coil voltage	Single side stable	1 coil latching	2 coil latching
		Part No.	Part No.	Part No.
2 Form C	1.5V DC	TQ2S□-1.5V-Z	TQ2S□-L-1.5V-Z	TQ2S□-L2-1.5V-Z
	3V DC	TQ2S□-3V-Z	TQ2S□-L-3V-Z	TQ2S□-L2-3V-Z
	4.5V DC	TQ2S□-4.5V-Z	TQ2S□-L-4.5V-Z	TQ2S□-L2-4.5V-Z
	5V DC	TQ2S□-5V-Z	TQ2S□-L-5V-Z	TQ2S□-L2-5V-Z
	6V DC	TQ2S□-6V-Z	TQ2S□-L-6V-Z	TQ2S□-L2-6V-Z
	9V DC	TQ2S□-9V-Z	TQ2S□-L-9V-Z	TQ2S□-L2-9V-Z
	12V DC	TQ2S□-12V-Z	TQ2S□-L-12V-Z	TQ2S□-L2-12V-Z
	24V DC	TQ2S□-24V-Z	TQ2S□-L-24V-Z	TQ2S□-L2-24V-Z
	48V DC	TQ2S□-48V-Z	—	—

□: For each surface-mounted terminal identification, input the following letter. SA type: A, SL type: L, SS type: S

Standard packing: Tape and reel: 500 pcs.; Case: 1,000 pcs.

Note: Tape and reel packing symbol "Z" is not marked on the relay. "X" type tape and reel packing (picked from 1/2/3/4-pin side) is also available.

RATING

■ Standard PC board terminal and self-clinching terminal

1. Coil data

[Standard (B.B.M.) type]

1) Single side stable (2 Form C)

Nominal coil voltage	Pick-up voltage (at 20°C 68°F)	Drop-out voltage (at 20°C 68°F)	Nominal operating current [±10%] (at 20°C 68°F)	Coil resistance [±10%] (at 20°C 68°F)	Nominal operating power	Max. applied voltage (at 20°C 68°F)
3V DC	75%V or less of nominal voltage* (Initial)	10%V or more of nominal voltage* (Initial)	46.7mA	64.3Ω	140mW	150%V of nominal voltage
4.5V DC			31.1mA	144.6Ω		
5V DC			28.1mA	178Ω		
6V DC			23.3mA	257Ω		
9V DC			15.5mA	579Ω		
12V DC			11.7mA	1,028Ω	200mW	
24V DC			8.3mA	2,880Ω		
48V DC			6.25mA	7,680Ω	300mW	120%V of nominal voltage

2) 1 coil latching (2 Form C)

Nominal coil voltage	Set voltage (at 20°C 68°F)	Reset voltage (at 20°C 68°F)	Nominal operating current [$\pm 10\%$] (at 20°C 68°F)	Coil resistance [$\pm 10\%$] (at 20°C 68°F)	Nominal operating power	Max. applied voltage (at 20°C 68°F)
3V DC	75%V or less of nominal voltage* (Initial)	75%V or less of nominal voltage* (Initial)	33.3mA	90 Ω	100mW	150%V of nominal voltage
4.5V DC			22.2mA	202.5 Ω		
5V DC			20mA	250 Ω		
6V DC			16.7mA	360 Ω		
9V DC			11.1mA	810 Ω		
12V DC			8.3mA	1,440 Ω		
24V DC			6.3mA	3,840 Ω	150mW	

3) 2 coil latching (2 Form C)

Nominal coil voltage	Set voltage (at 20°C 68°F)	Reset voltage (at 20°C 68°F)	Nominal operating current [$\pm 10\%$] (at 20°C 68°F)		Coil resistance [$\pm 10\%$] (at 20°C 68°F)		Nominal operating power		Max. applied voltage (at 20°C 68°F)
			Set coil	Reset coil	Set coil	Reset coil	Set coil	Reset coil	
3V DC	75%V or less of nominal voltage* (Initial)	75%V or less of nominal voltage* (Initial)	66.7mA	66.7mA	45 Ω	45 Ω	200mW	200mW	150%V of nominal voltage
4.5V DC			44.4mA	44.4mA	101.2 Ω	101.2 Ω			
5V DC			40mA	40mA	125 Ω	125 Ω			
6V DC			33.3mA	33.3mA	180 Ω	180 Ω			
9V DC			22.2mA	22.2mA	405 Ω	405 Ω			
12V DC			16.7mA	16.7mA	720 Ω	720 Ω			
24V DC			12.5mA	12.5mA	1,920 Ω	1,920 Ω	300mW	300mW	

4) Single side stable (4 Form C)

Nominal coil voltage	Pick-up voltage (at 20°C 68°F)	Drop-out voltage (at 20°C 68°F)	Nominal operating current [$\pm 10\%$] (at 20°C 68°F)	Coil resistance [$\pm 10\%$] (at 20°C 68°F)	Nominal operating power	Max. applied voltage (at 20°C 68°F)
3V DC	75%V or less of nominal voltage* (Initial)	10%V or more of nominal voltage* (Initial)	93.8mA	32 Ω	280mW	150%V of nominal voltage
4.5V DC			62.2mA	72.3 Ω		
5V DC			56.2mA	89 Ω		
6V DC			46.5mA	129 Ω		
9V DC			31.1mA	289 Ω		
12V DC			23.3mA	514 Ω		
24V DC			11.7mA	2,056 Ω	400mW	

5) 1 coil latching (4 Form C)

Nominal coil voltage	Set voltage (at 20°C 68°F)	Reset voltage (at 20°C 68°F)	Nominal operating current [$\pm 10\%$] (at 20°C 68°F)	Coil resistance [$\pm 10\%$] (at 20°C 68°F)	Nominal operating power	Max. applied voltage (at 20°C 68°F)
3V DC	75%V or less of nominal voltage* (Initial)	75%V or less of nominal voltage* (Initial)	66.6mA	45 Ω	200mW	150%V of nominal voltage
4.5V DC			44.4mA	101.2 Ω		
5V DC			40mA	125 Ω		
6V DC			33.3mA	180 Ω		
9V DC			22.2mA	405 Ω		
12V DC			16.7mA	720 Ω		
24V DC			8.3mA	2,880 Ω		

6) 2 coil latching (4 Form C)

Nominal coil voltage	Set voltage (at 20°C 68°F)	Reset voltage (at 20°C 68°F)	Nominal operating current [$\pm 10\%$] (at 20°C 68°F)		Coil resistance [$\pm 10\%$] (at 20°C 68°F)		Nominal operating power		Max. applied voltage (at 20°C 68°F)
			Set coil	Reset coil	Set coil	Reset coil	Set coil	Reset coil	
3V DC	75%V or less of nominal voltage* (Initial)	75%V or less of nominal voltage* (Initial)	133mA	133mA	22.5 Ω	22.5 Ω	400mW	400mW	150%V of nominal voltage
4.5V DC			88.9mA	88.9mA	50.6 Ω	50.6 Ω			
5V DC			80mA	80mA	62.5 Ω	62.5 Ω			
6V DC			66.6mA	66.6mA	90 Ω	90 Ω			
9V DC			44.4mA	44.4mA	202.5 Ω	202.5 Ω			
12V DC			33.3mA	33.3mA	360 Ω	360 Ω			
24V DC			16.7mA	16.7mA	1,440 Ω	1,440 Ω			

*Pulse drive (JIS C 5442-1986)

[M.B.B. type]

Nominal coil voltage	Pick-up voltage (at 20°C 68°F)	Drop-out voltage (at 20°C 68°F)	Nominal operating current [±10%] (at 20°C 68°F)	Coil resistance [±10%] (at 20°C 68°F)	Nominal operating power	Max. applied voltage (at 20°C 68°F)
3V DC	80%V or less of nominal voltage* (Initial)	10%V or more of nominal voltage* (Initial)	66.7mA	45Ω	200mW	150%V of nominal voltage
4.5V DC			44.4mA	101Ω		
5V DC			40mA	125Ω		
6V DC			33.3mA	180Ω		
9V DC			22.2mA	405Ω		
12V DC			16.7mA	720Ω		
24V DC			8.3mA	2,880Ω		

*Pulse drive (JIS C 5442-1986)

2. Specifications

Characteristics	Item	Specifications	
Contact	Arrangement	2 Form C, 2 Form D (M.B.B.) 4 Form C	
	Initial contact resistance, max.	Max. 50mΩ (By voltage drop 6 V DC 1A)	
	Contact material	Ag+Au clad	
Rating	Nominal switching capacity	1 A 30 V DC, 0.5 A 125 V AC*1 (resistive load)	
	Max. switching power	30 W (DC), 62.5 V A (AC)*1 (resistive load)	
	Max. switching voltage	110 V DC, 125 V AC*1	
	Max. switching current	1 A	
	Min. switching capacity (Reference value)*2	10μA 10mV DC	
	Nominal operating power	Single side stable	Standard (B.B.M) type: 140 mW (3 to 12 V DC), 200 mW (24 V DC), 300 mW (48 V DC) M.B.B. type: 200 mW
1 coil latching		100 mW (3 to 12 V DC), 150 mW (24 V DC)	
2 coil latching		200 mW (3 to 12 V DC), 300 mW (24 V DC)	
Electrical characteristics	Insulation resistance (Initial)	Min. 1,000MΩ (at 500V DC) Measurement at same location as "Initial breakdown voltage" section.	
	Breakdown voltage (Initial)	Between open contacts	Standard (B.B.M) type: 750 Vrms for 1min. (Detection current: 10 mA), M.B.B. type: 300 Vrms for 1 min. (Detection current: 10 mA)
		Between contact and coil	1,000 Vrms for 1min. (Detection current: 10 mA)
		Between contact sets	1,000 Vrms for 1min. (Detection current: 10 mA)
	Temperature rise (at 20°C 68°F)	Max. 50°C (By resistive method, nominal coil voltage applied to the coil; contact carrying current: 1A.)	
Operate time [Set time] (at 20°C 68°F)	Max. 3 ms [Max. 3 ms] (Nominal coil voltage applied to the coil, excluding contact bounce time.)		
Release time [Reset time] (at 20°C 68°F)	Max. 3 ms [Max. 3 ms] (Nominal coil voltage applied to the coil, excluding contact bounce time.) (without diode)		
Mechanical characteristics	Shock resistance	Functional	Min. 490 m/s ² (Half-wave pulse of sine wave: 11 ms; detection time: 10μs.)
		Destructive	Min. 980 m/s ² (Half-wave pulse of sine wave: 6 ms.)
	Vibration resistance	Functional	10 to 55 Hz at double amplitude of 3 mm (Detection time: 10μs.)
Destructive		10 to 55 Hz at double amplitude of 5 mm	
Expected life	Mechanical (at 180 cpm)	Standard (B.B.M) type: Min. 10 ⁸ , M.B.B. type: Min. 10 ⁷	
	Electrical (at 20 cpm)	Standard (B.B.M) type: Min. 2×10 ⁵ (1 A 30 V DC resistive), Min. 10 ⁵ (0.5 A 125 V AC resistive) M.B.B. type: Min. 10 ⁵ (1 A 30 V DC resistive)	
Conditions	Conditions for operation, transport and storage*3	Standard (B.B.M) type: Ambient temperature: -40°C to +70°C -40°F to +158°F; Humidity: 5 to 85% R.H. (Not freezing and condensing at low temperature) M.B.B. type: Ambient temperature: -40°C to +50°C -40°F to +122°F; Humidity: 5 to 85% R.H. (Not freezing and condensing at low temperature)	
	Max. operating speed (at rated load)	20 cpm	
Unit weight		Approx. 1.5 g .053 oz Approx. 3 g .106 oz.	

Notes: *1 AC is standard (B.B.M) type only.

*2 This value can change due to the switching frequency, environmental conditions, and desired reliability level, therefore it is recommended to check this with the actual load. (SX relays are available for low level load switching [10V DC, 10mA max. level])

*3 Refer to "6. Usage, Storage and Transport Conditions" in [AMBIENT ENVIRONMENT section in Relay Technical Information](#).

■ Surface-mount terminal

1. Coil data**1) Single side stable**

Nominal coil voltage	Pick-up voltage (at 20°C 68°F)	Drop-out voltage (at 20°C 68°F)	Nominal operating current (at 20°C 68°F)	Coil resistance [±10%] (at 20°C 68°F)	Nominal operating power	Max. applied voltage (at 20°C 68°F)
1.5V DC	75%V or less of nominal voltage* (Initial)	10%V or more of nominal voltage* (Initial)	93.8mA	16Ω	140mW	150%V of nominal voltage
3V DC			46.7mA	64.3Ω		
4.5V DC			31mA	145Ω		
5V DC			28.1mA	178Ω		
6V DC			23.3mA	257Ω		
9V DC			15.5mA	579Ω		
12V DC			11.7mA	1,028Ω		
24V DC			8.3mA	2,880Ω	200mW	
48V DC			6.3mA	7,680Ω	300mW	120%V of nominal voltage

2) 1 coil latching

Nominal coil voltage	Set voltage (at 20°C 68°F)	Reset voltage (at 20°C 68°F)	Nominal operating current (at 20°C 68°F)	Coil resistance [±10%] (at 20°C 68°F)	Nominal operating power	Max. applied voltage (at 20°C 68°F)
1.5V DC	75%V or less of nominal voltage* (Initial)	75%V or less of nominal voltage* (Initial)	46.9mA	32Ω	70mW	150%V of nominal voltage
3V DC			23.3mA	128.6Ω		
4.5V DC			15.6mA	289.3Ω		
5V DC			14mA	357Ω		
6V DC			11.7mA	514Ω		
9V DC			7.8mA	1,157Ω		
12V DC			5.8mA	2,057Ω		
24V DC			4.2mA	5,760Ω	100mW	

3) 2 coil latching

Nominal coil voltage	Set voltage (at 20°C 68°F)	Reset voltage (at 20°C 68°F)	Nominal operating current (at 20°C 68°F)		Coil resistance [±10%] (at 20°C 68°F)		Nominal operating power		Max. applied voltage (at 20°C 68°F)
			Set coil	Reset coil	Set coil	Reset coil	Set coil	Reset coil	
1.5V DC	75%V or less of nominal voltage* (Initial)	75%V or less of nominal voltage* (Initial)	93.8mA	93.8mA	16Ω	16Ω	140mW	140mW	150%V of nominal voltage
3V DC			46.7mA	46.7mA	64.3Ω	64.3Ω			
4.5V DC			31mA	31mA	145Ω	145Ω			
5V DC			28.1mA	28.1mA	178Ω	178Ω			
6V DC			23.3mA	23.3mA	257Ω	257Ω			
9V DC			15.5mA	15.5mA	579Ω	579Ω			
12V DC			11.7mA	11.7mA	1,028Ω	1,028Ω			
24V DC			8.3mA	8.3mA	2,880Ω	2,880Ω	200mW	200mW	

*Pulse drive (JIS C 5442-1986)

2. Specifications

Characteristics	Item	Specifications	
Contact	Arrangement	2 Form C	
	Initial contact resistance, max.	Max. 75 mΩ (By voltage drop 6 V DC 1A)	
	Contact material	AgNi type+Au clad	
Rating	Nominal switching capacity	2 A 30 V DC, 0.5 A 125 V AC (resistive load)	
	Max. switching power	60 W (DC), 62.5 VA (AC) (resistive load)	
	Max. switching voltage	220 V DC, 125 V AC	
	Max. switching current	2 A	
	Min. switching capacity (Reference value)*1	10μA 10mV DC	
	Nominal operating power	Single side stable 1 coil latching 2 coil latching	140 mW (1.5 to 12 V DC), 200 mW (24 V DC), 300 mW (48 V DC) 70 mW (1.5 to 12 V DC), 100 mW (24 V DC) 140 mW (1.5 to 12 V DC), 200 mW (24 V DC)
Electrical characteristics	Insulation resistance (Initial)	Min. 1,000MΩ (at 500V DC) Measurement at same location as "Initial breakdown voltage" section.	
	Breakdown voltage (Initial)	Between open contacts	1,000 Vrms for 1 min. (Detection current: 10 mA)
		Between contact and coil	1,500 Vrms for 1 min. (Detection current: 10 mA)
		Between contact sets	1,500 Vrms for 1 min. (Detection current: 10 mA)
	Surge breakdown voltage (Initial)	Between open contacts	1,500 V (10×160μs) (FCC Part 68)
		Between contacts and coil	2,500 V (2×10μs) (Bellcore)
	Temperature rise (at 20°C 68°F)	Max. 50°C (By resistive method, nominal coil voltage applied to the coil; contact carrying current: 2A.)	
Operate time [Set time] (at 20°C 68°F)	Max. 4 ms [Max. 4 ms] (Nominal coil voltage applied to the coil, excluding contact bounce time.)		
Release time [Reset time] (at 20°C 68°F)	Max. 4 ms [Max. 4 ms] (Nominal coil voltage applied to the coil, excluding contact bounce time.) (without diode)		
Mechanical characteristics	Shock resistance	Functional	Min. 750 m/s ² (Half-wave pulse of sine wave: 6 ms; detection time: 10μs.)
		Destructive	Min. 1,000 m/s ² (Half-wave pulse of sine wave: 6 ms.)
	Vibration resistance	Functional	10 to 55 Hz at double amplitude of 3.3 mm (Detection time: 10μs.)
		Destructive	10 to 55 Hz at double amplitude of 5 mm
Expected life	Mechanical	Min. 10 ⁸ (at 180 cpm)	
	Electrical	Min. 10 ⁵ (2 A 30 V DC resistive), Min. 2×10 ⁵ (1 A 30 V DC resistive), Min. 10 ⁵ (0.5 A 125 V AC resistive) (at 20 cpm)	
Conditions	Conditions for operation, transport and storage*2	Ambient temperature: -40°C to +85°C -40°F to +185°F, Max. -40°C to +70°C (2A) Max. -40°F to +158°F (2A); Humidity: 5 to 85% R.H. (Not freezing and condensing at low temperature)	
	Max. operating speed (at rated load)	20 cpm	
Unit weight		Approx. 2 g .071 oz	

Notes: *1 This value can change due to the switching frequency, environmental conditions, and desired reliability level, therefore it is recommended to check this with the actual load. (SX relays are available for low level load switching [10V DC, 10mA max. level])

*2 Refer to "6. Usage, Storage and Transport Conditions" in [AMBIENT ENVIRONMENT](#) section in [Relay Technical Information](#).

REFERENCE DATA

Standard PC board terminal and self-clinching terminal

1. Maximum switching capacity

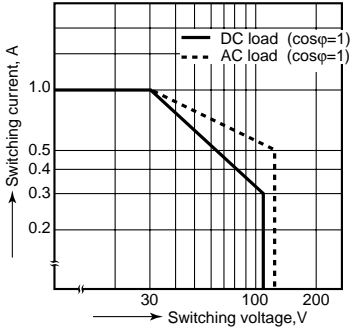

2. Life curve

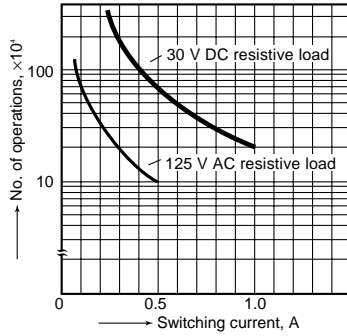

3. Mechanical life

Tested sample: TQ2-12V, 10 pcs.

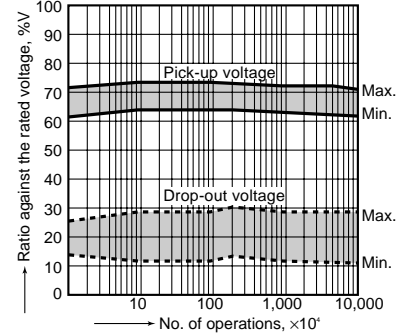

4.-(1) Electrical life (DC load)

Tested sample: TQ2-12V, 6 pcs.
Condition: 1 A 30 V DC resistive load, 20 cpm
Change of pick-up and drop-out voltage

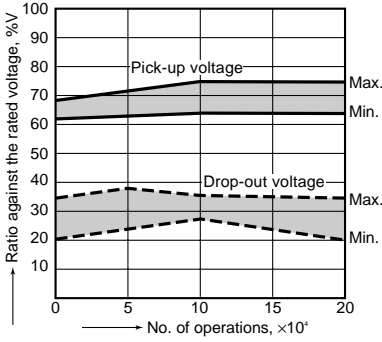

Change of contact resistance

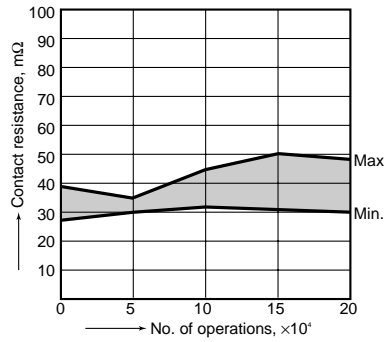

4.-(2) Electrical life (AC load)

Tested sample: TQ2-12V, 6 pcs.
Condition: 0.5 A 125 V AC resistive load, 20 cpm
Change of pick-up and drop-out voltage

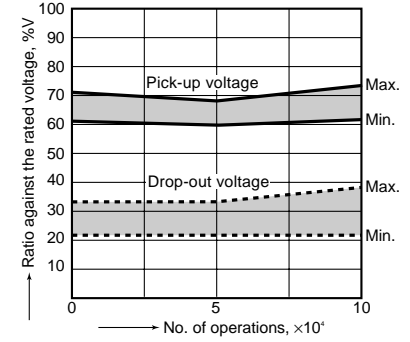

5. Coil temperature rise (2C)

Tested sample: TQ2-12V
Measured portion: Inside the coil
Ambient temperature: 30°C 86°F

Change of contact resistance

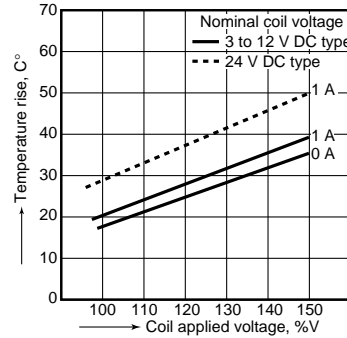
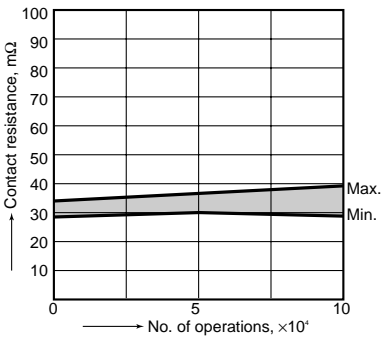

6. Ambient temperature characteristics

Tested sample: TQ2-12V, 5 pcs.

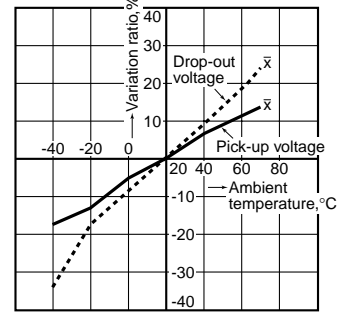

7.-(1) High-frequency characteristics (Isolation)

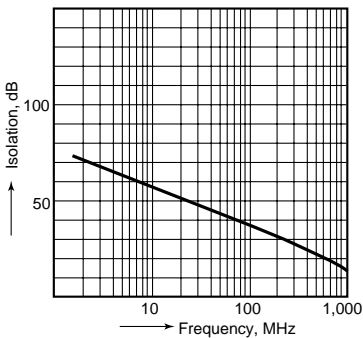

7.-(2) High-frequency characteristics (Insertion loss)

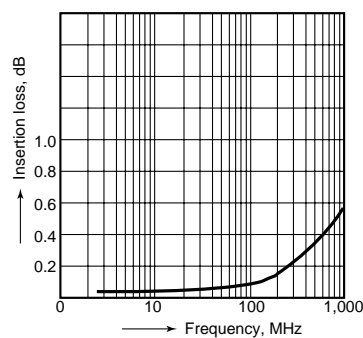

8. Malfunctional shock (single side stable)

Tested sample: TQ2-12V, 6 pcs.

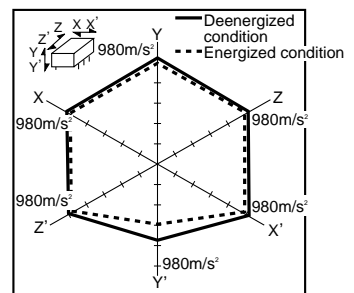

9.-(1) Influence of adjacent mounting

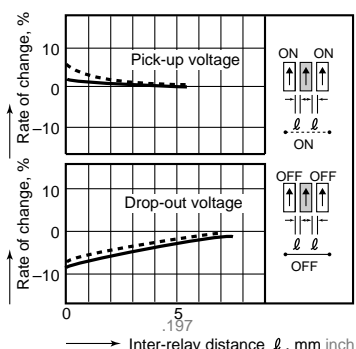

9.-(2) Influence of adjacent mounting

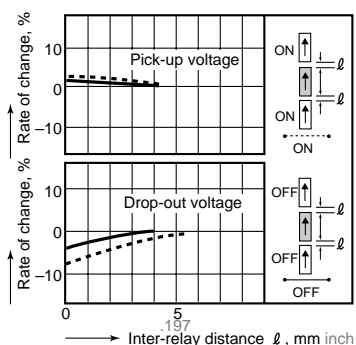

10. Contact reliability
(1 mA 5 V DC resistive load)
Tested sample: TQ2-12V
Condition: Detection level 10 W

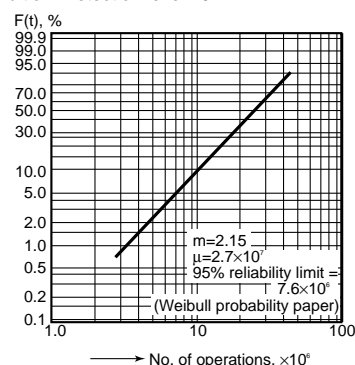

11. Actual load test (35 mA 48 V DC wire spring relay load)

Circuit

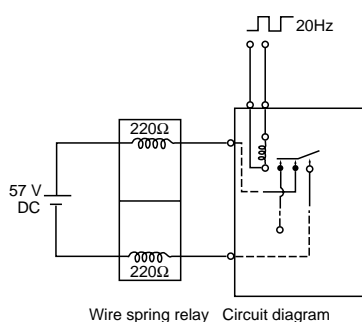

Change of pick-up and drop-out voltage

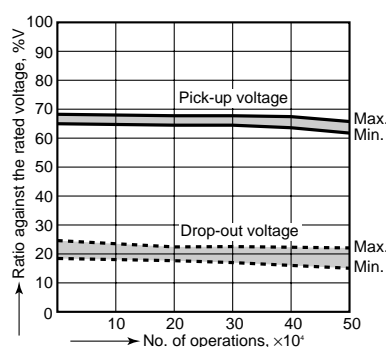

Change of contact resistance

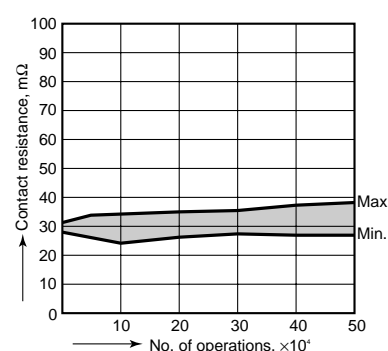

12. 0.1 A 53 V DC resistive load test

Change of pick-up and drop-out voltage

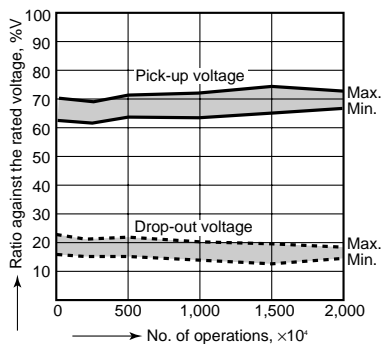

Change of contact resistance

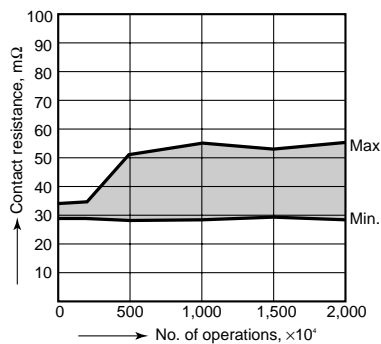

13. Distribution of M.B.B. time

Tested sample: TQ2-2M-5V, 85 pcs.

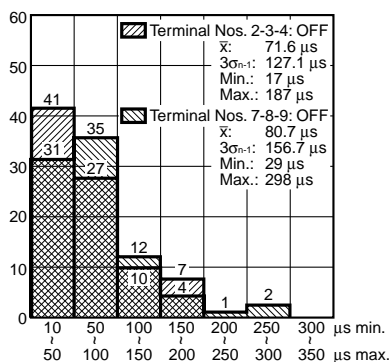
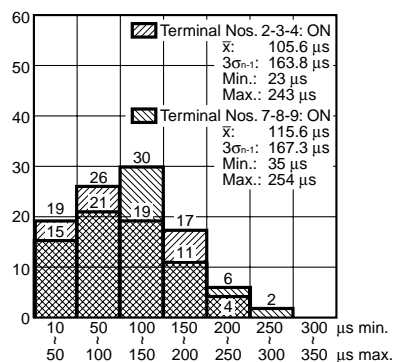

■ Surface-mount terminal

1. Maximum switching capacity

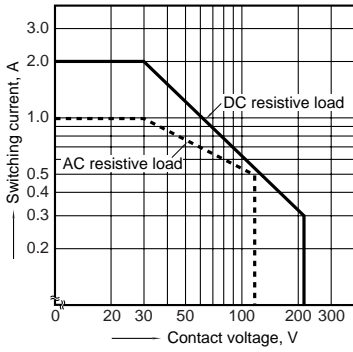

2. Life curve

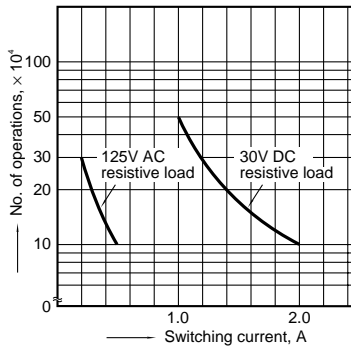

3. Mechanical life (mounting by IRS method)

Tested sample: TQ2SA-12V, 10 pcs.

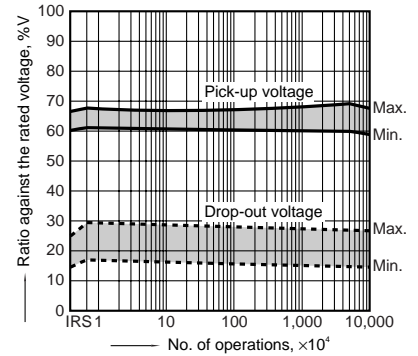

4.-(1) Electrical life (2 A 30 V DC resistive load)

Tested sample: TQ2SA-12V, 6 pcs.
Operating speed: 20 cpm
Change of pick-up and drop-out voltage (mounting by IRS method)

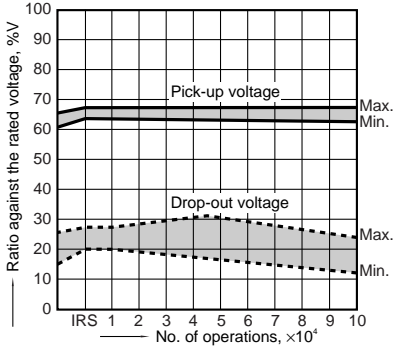

Change of contact resistance (mounting by IRS method)

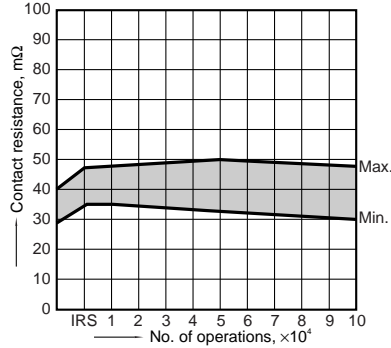

4.-(2) Electrical life (0.5 A 125 V AC resistive load)

Tested sample: TQ2SA-12V, 6 pcs
Operating speed: 20 cpm
Change of pick-up and drop-out voltage (mounting by IRS method)

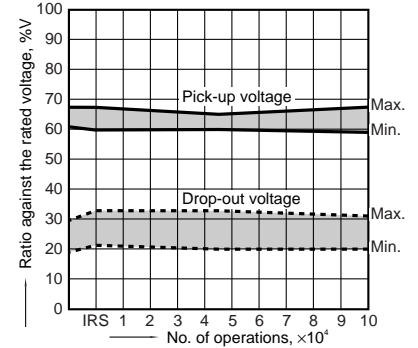

Change of contact resistance (mounting by IRS method)

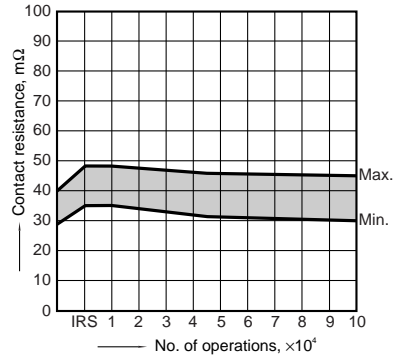

5. Coil temperature rise

Tested sample: TQ2SA-12V, 6 pcs.
Point measured: Inside the coil
Ambient temperature: 25°C 77°F

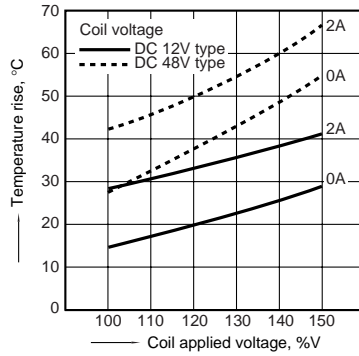

6. Operate/release time

Tested sample: TQ2SA-12V, 6 pcs.

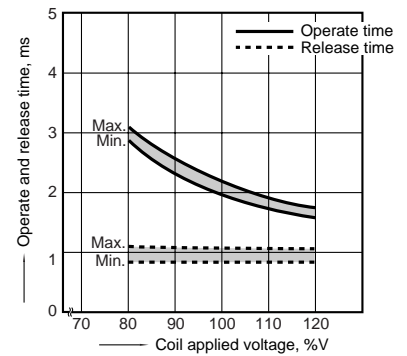

7. Ambient temperature characteristics

Tested sample: TQ2SA-12V, 5 pcs.

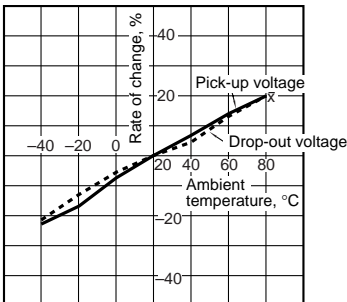

8.-(1) High-frequency characteristics (Isolation)

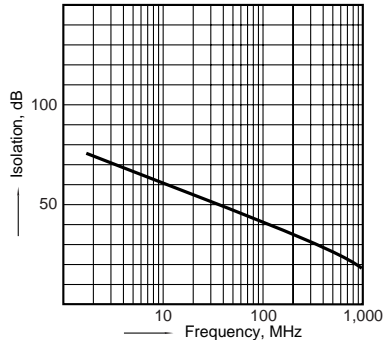

8.-(2) High-frequency characteristics (Insertion loss)

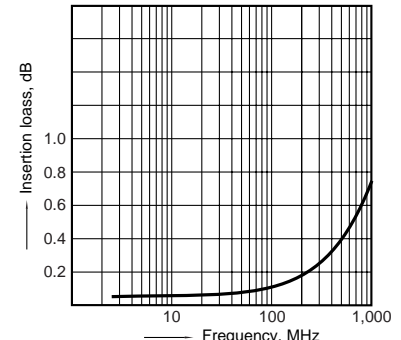

9. Malfunctional shock (single side stable)

Tested sample: TQ2SA-12V, 6 pcs

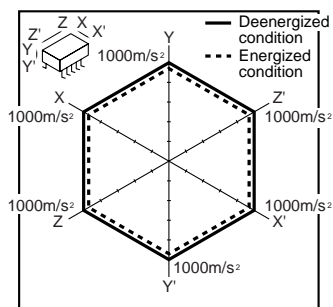

10.-(1) Influence of adjacent mounting

Tested sample: TQ2SA-12V, 5 pcs.

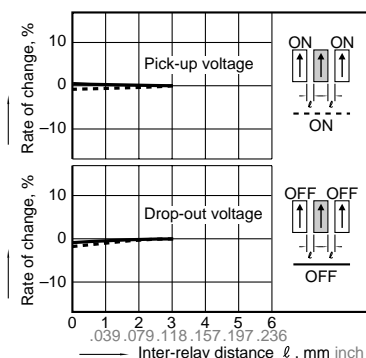

10.-(2) Influence of adjacent mounting

Tested sample: TQ2SA-12V, 6 pcs.

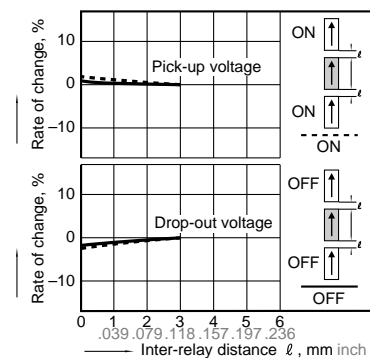

11. Pulse dialing test

(35 mA 48 V DC wire spring relay load)

Tested sample: TQ2SA-12V, 6 pcs.

Circuit

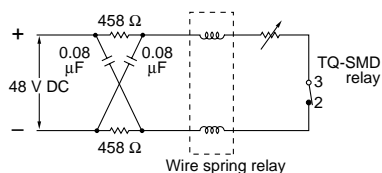

Change of pick-up and drop-out voltage (mounting by IRS method)

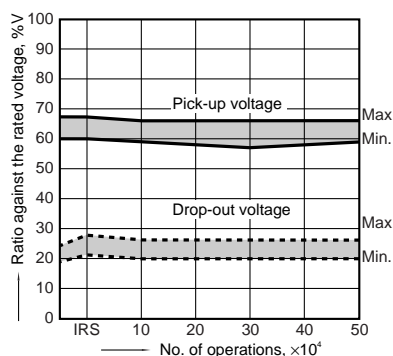

Change of contact resistance (mounting by IRS method)

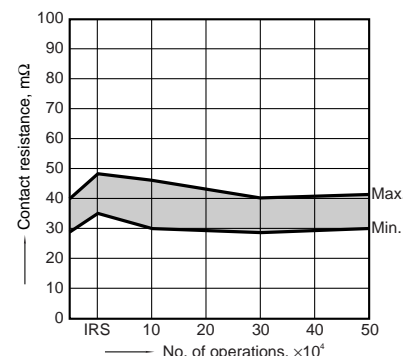

DIMENSIONS (mm inch) Interested in CAD data? You can obtain CAD data for all products with a **CAD Data** mark from [your local Panasonic Electric Works representative](#).

1. Standard PC board terminal and Self-clinching terminal
1) 2 Form C

CAD Data

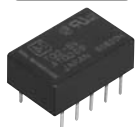

External dimensions
Standard PC board terminal

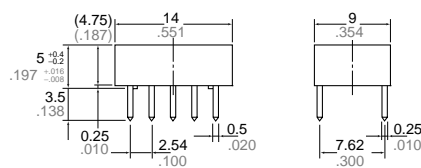

PC board pattern (Bottom view)

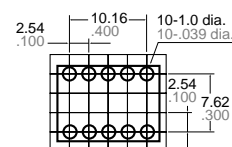

Tolerance: $\pm 0.1 \pm 0.004$

Self-clinching terminal

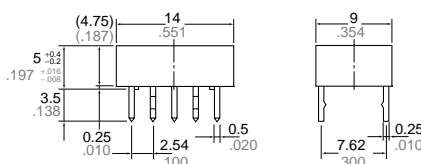

General tolerance: $\pm 0.3 \pm 0.012$

Schematic (Bottom view)

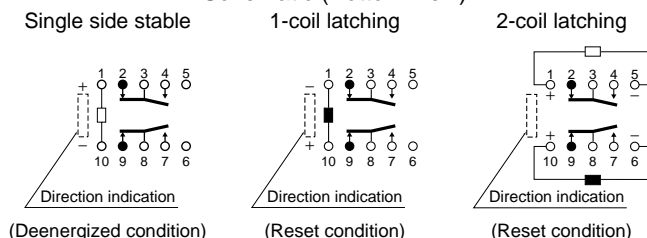

2) 4 Form C

CAD Data

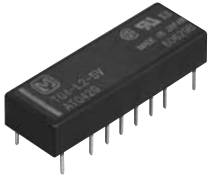

External dimensions
Standard PC board terminal

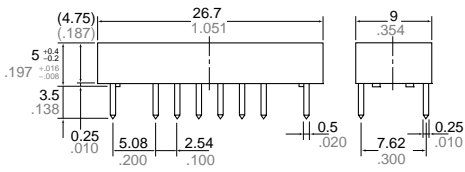

PC board pattern (Bottom view)

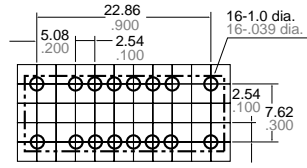

Tolerance: $\pm 0.1 \pm 0.04$

Self-clinching terminal

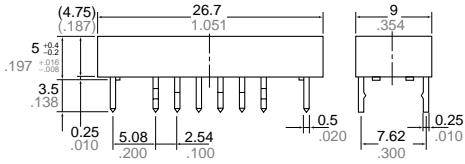

General tolerance: $\pm 0.3 \pm 0.12$

Schematic (Bottom view)

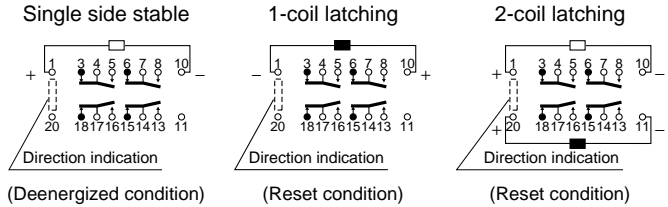

2. Surface-mount terminal

CAD Data



Type	External dimensions (General tolerance: $\pm 0.3 \pm 0.12$)	Suggested mounting pad (Top view) (Tolerance: $\pm 0.1 \pm 0.04$)
SA type		
SL type		
SS type		

Schematic (Top view)

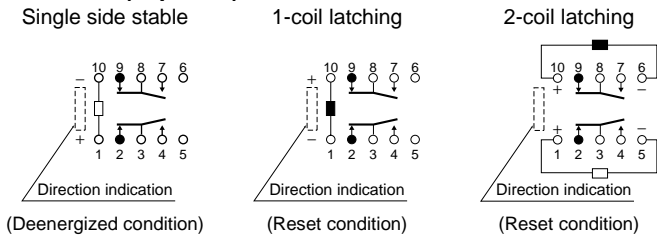

NOTES

1. Packing style

1) The relay is packed in a tube with the relay orientation mark on the left side, as shown in the figure below.

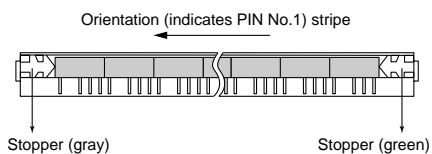

2) Tape and reel packing (surface-mount terminal type)

(1) Tape dimensions

(i) SA type

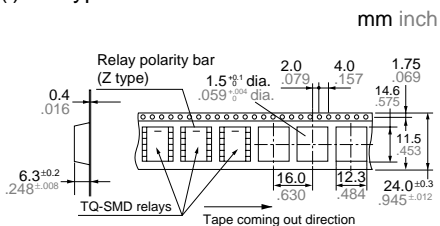

(ii) SL, SS type

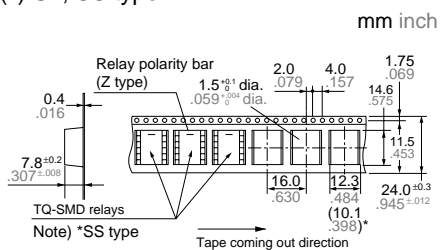

(2) Dimensions of plastic reel

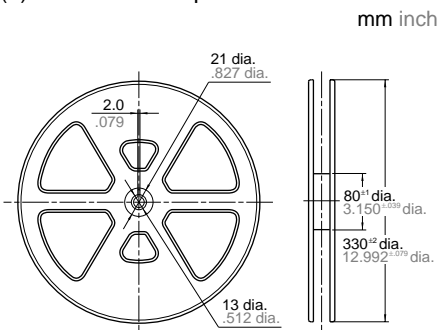

2. Automatic insertion

To maintain the internal function of the relay, the chucking pressure should not exceed the values below.

Chucking pressure in the direction A:
9.8 N {1 kgf} or less

Chucking pressure in the direction B:
9.8 N {1 kgf} or less

Chucking pressure in the direction C:
9.8 N {1 kgf} or less

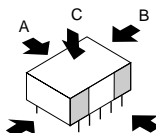

Please chuck the  portion.
Avoid chucking the center of the relay.
In addition, excessive chucking pressure to the pinpoint of the relay should be avoided.

For Cautions for Use, see [Relay Technical Information](#).