

S9705 series

Converts light level to frequency of output pulse

The S9705 and S9705-01DT are photo ICs that combine a photodiode and a current-to-frequency converter on a CMOS chip. Output is a square wave (50% duty ratio) with frequency directly proportional to light level incident on the photodiode. The CMOS level digital output allows direct connection to a microcontroller or other logic circuitry. The S9705 series has wide dynamic range and light level can be easily measured when used with a digital counter.

Features

- Converts light level to frequency
- Wide dynamic range: 5 orders of magnitude
- Excellent linearity
- Output timing reset function
- Digital output for direct interface to microcontroller
- 4-pin plastic package

Applications

- Liquid crystal monitor backlight dimmer for mobile devices
- Brightness adjustment for large-screen liquid crystal TV
- Lighting dimmer
- Replacement for CdS photoconductive cells

Absolute maximum ratings

Parameter	Symbol	Condition	Value	Unit
Supply voltage	Vdd	Ta=25 °C	-0.3 to +6	V
Load current	Io	Ta=25 °C	±2	mA
Power dissipation	P	Ta=25 °C	50	mW
Operating temperature	Topr	No dew condensation*1	-40 to +85	°C
Storage temperature	Tstg	No dew condensation*1	-40 to +100	°C
Reflow soldering conditions*1	S9705*2	Tsol	Peak temperature 250 °C max, 2times(see page 7)	
	S9705-01DT*3		Peak temperature 240 °C max, 2 times	

*1: When there is a temperature difference between a product and the surrounding area in high humidity environment, dew condensation may occur on the product surface. Dew condensation on the product may cause deterioration in characteristics and reliability.

*2: JEDEC level 4

*3: JEDEC level 5a

Note: Exceeding the absolute maximum ratings even momentarily may cause a drop in product quality. Always be sure to use the product within the absolute maximum ratings.

Electrical and optical characteristics (RESET="L", Vdd=5 V, Ta=25 °C, unless otherwise noted)

Parameter	Symbol	Condition	S9705			S9705-01DT			Unit
			Min.	Typ.	Max.	Min.	Typ.	Max.	
Peak sensitivity wavelength	λ_p		-	550	-	-	620	-	nm
Supply voltage	Vdd		2.7	-	5.5	2.7	-	5.5	V
Current consumption	Idd	Dark state, no load	-	1.5	3.0	-	1.5	3.0	mA
Output frequency	fo	2856 K ^{*4}	38	50	62	30	40	50	kHz
Maximum output frequency	fmax	10 klx, DC light source	300	-	1000	300	-	1200	kHz
Response time	tfl	5 lx to 5 mlx, 90%	-	-	0.1	-	-	0.1	s
Dark frequency	fd		0	-	2	0	-	2	Hz
Linearity	-	fo=10 kHz ^{*5}	-3	-	+3	-3	-	+3	%
Power supply voltage dependence of output frequency	-	Vdd=5 V ± 10%	-	±0.5	-	-	±0.5	-	%
Temperature coefficient of output frequency	-	Ta=25 ± 10 °C, fo=10 kHz $\lambda = \lambda_p$	-	±0.02	-	-	±0.02	-	%/°C
Delay time	td		-	-	0.1	-	-	0.1	µs
High level output voltage	Voh	Ioh=-0.5 mA	4.5	-	-	4.5	-	-	V
Low level output voltage	Vol	Iol=0.5 mA	-	-	0.5	-	-	0.5	V
Output impedance	Ro	RESET="H"	1	-	-	1	-	-	MΩ
High level input voltage	Vih	RESET	4.0	-	-	4.0	-	-	V
Low level input voltage	Vil	RESET	-	-	1.0	-	-	0.1	V
Input pull-up resistance	Rin	RESET="L"	0.1	1	5	0.1	1	5	MΩ
Output pulse duty ratio	D	fo=10 Hz	40	50	60	40	50	60	%

*4: S9705=100 lx, S9705-01DT=20 lx

*5: Deviation from the straight line connecting the origin point to the fmax point, normalized by the 10 kHz value.

Spectral response

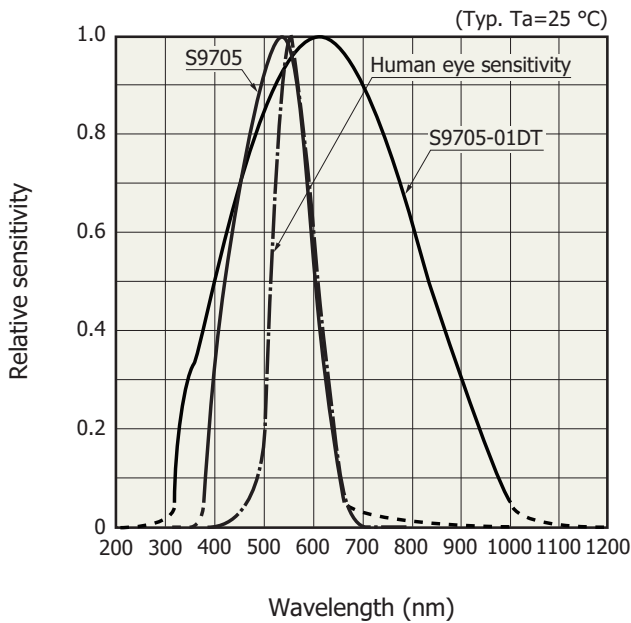

KPICB0093EC

Output frequency vs. illuminance

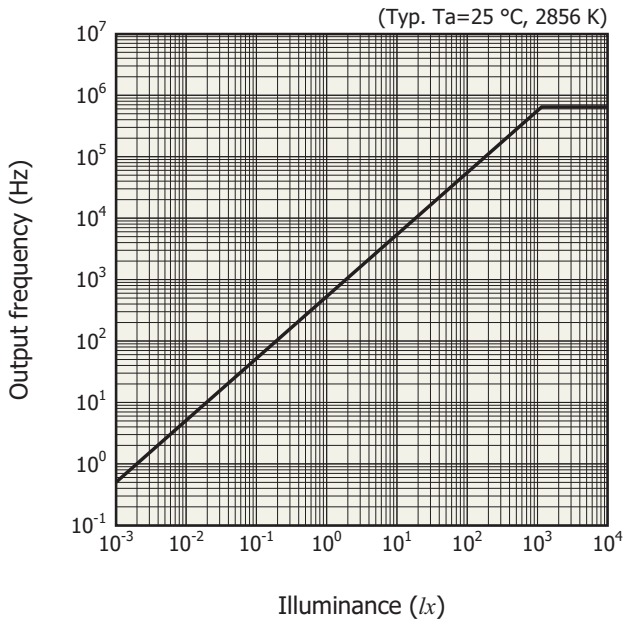

KPICB0091EC

Timing chart

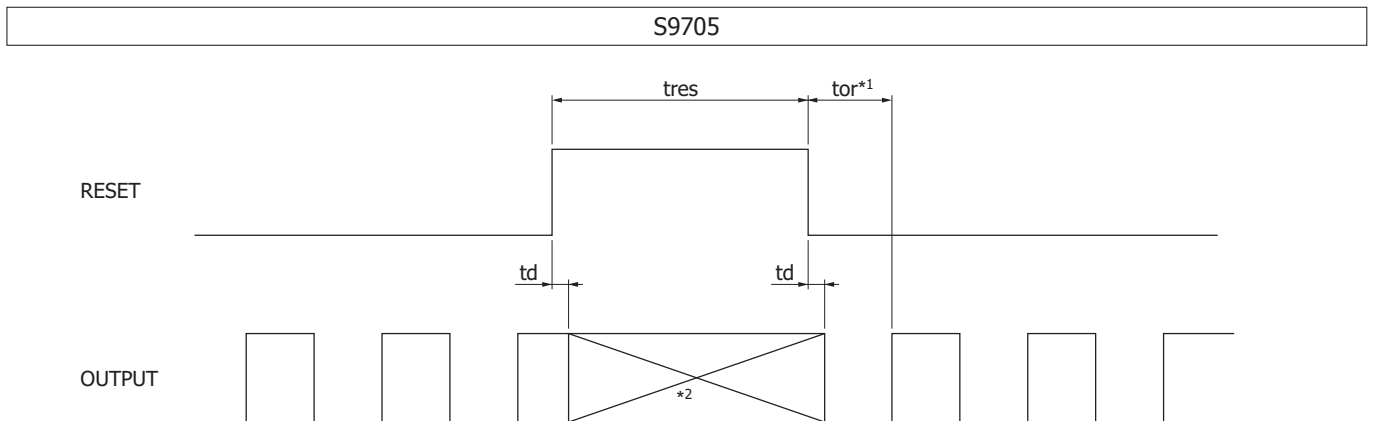

*1: Output starts with "Low" after releasing RESET. Illuminance can be obtained by measuring the time (tor) required before the first output transition after releasing RESET. (tres is recommended to be longer than 1 μs.)
 *2: OUTPUT terminal is at High impedance during RESET period ("High" state).

KPIC0120EF

S9705-01DT

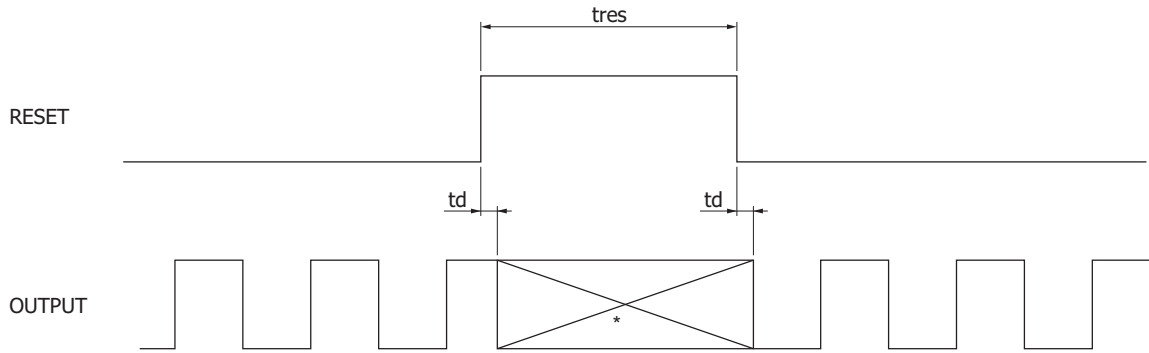

* OUTPUT terminal is at High impedance during RESET period ("High" state).

KPIC0275EA

Dimensional outline (unit: mm)

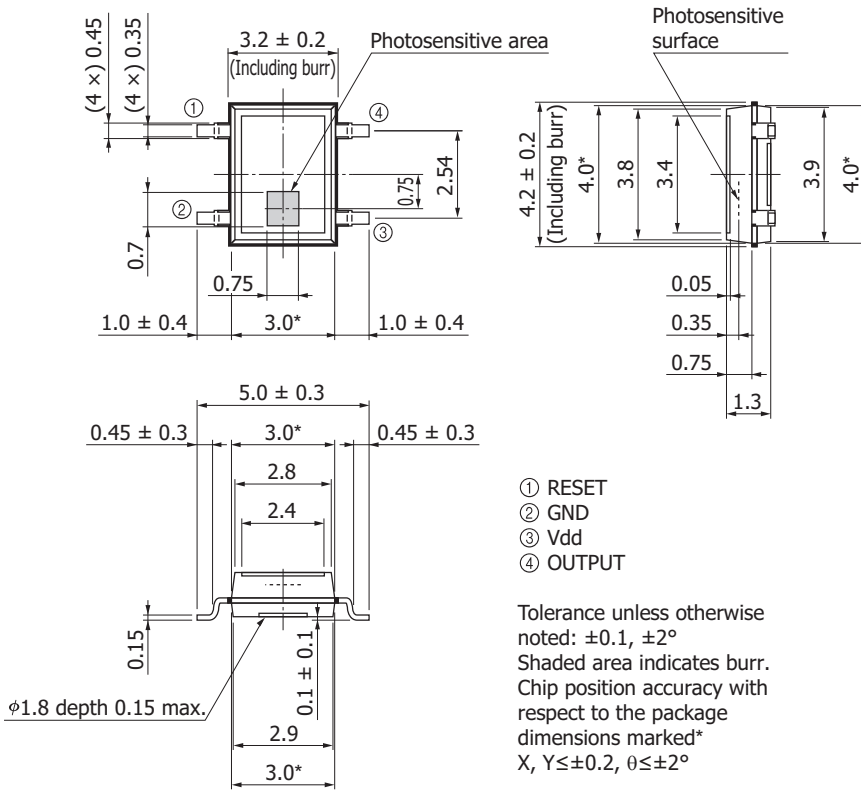

KPICA0063EE

Pin connections

Pin no.	Symbol	Function	Input/Output
1	RESET	Out disable	Input (digital)
2	GND	Ground	-
3	Vdd	Supply terminal	-
4	OUTPUT	Output terminal	Output (digital)

Equivalent input circuit

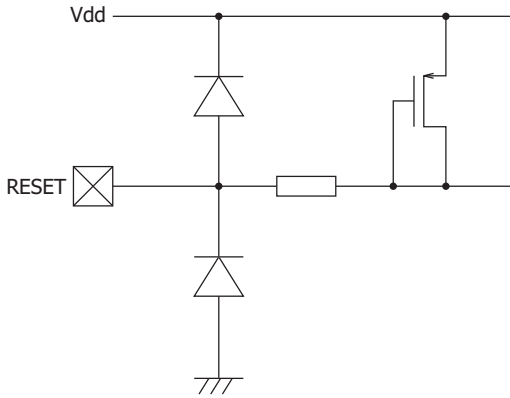

KPIC0276EA

Recommended land pattern (unit: mm)

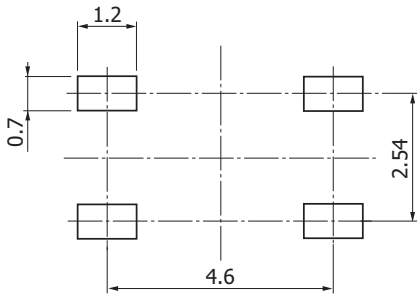

KPIC0191EA

Standard packing specifications

- Reel (conforms to JEITA ET-7200)

Dimensions	Hub diameter	Tape width	Material	Electrostatic characteristics
254 mm	80 mm	12 mm	PS	Conductive

- Embossed tape (unit: mm, material: PS, conductive)

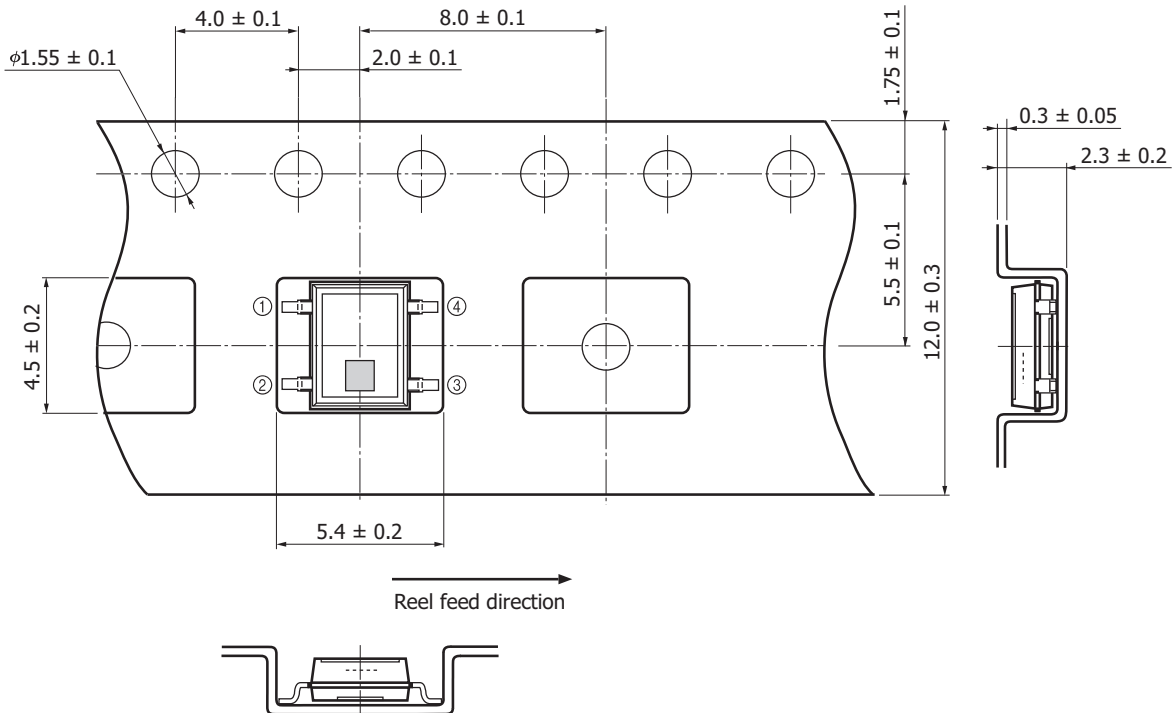

KPINCO195EA

- Packing quantity
2000 pcs/reel
- Packing type
Reel and desiccant in moisture-proof packaging (vacuum-sealed)

Measured example of temperature profile with our hot-air reflow oven for product testing (S9705)

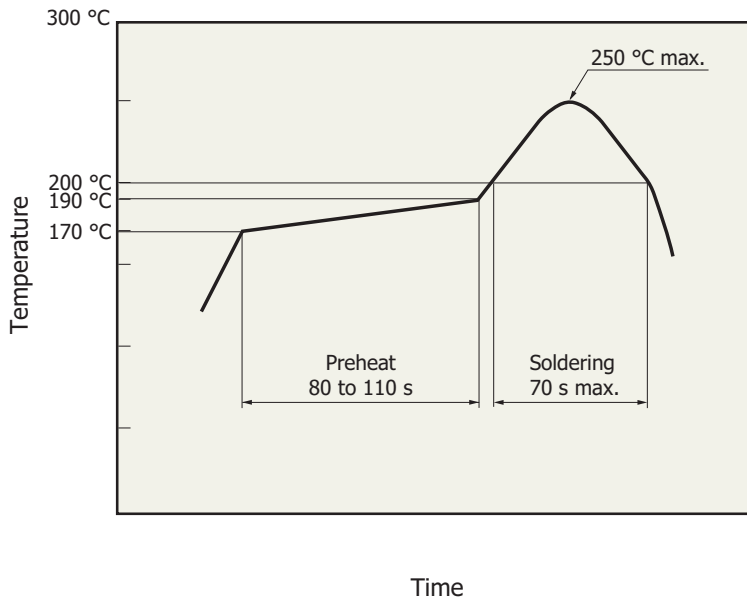

KPICB0173EA

- This product supports lead-free soldering. After unpacking, store it in an environment at a temperature of 30 °C or less and a humidity of 60% or less, and perform soldering within 72 hours.
- The effect that the product receives during reflow soldering varies depending on the circuit board and reflow oven that are used. Before actual reflow soldering, check for any problems by testing out the reflow soldering methods in advance.

Related information

www.hamamatsu.com/sp/ssd/doc_en.html

■ Precautions

- Disclaimer
- Surface mount type products

Information described in this material is current as of April, 2016.

Product specifications are subject to change without prior notice due to improvements or other reasons. This document has been carefully prepared and the information contained is believed to be accurate. In rare cases, however, there may be inaccuracies such as text errors. Before using these products, always contact us for the delivery specification sheet to check the latest specifications.

The product warranty is valid for one year after delivery and is limited to product repair or replacement for defects discovered and reported to us within that one year period. However, even if within the warranty period we accept absolutely no liability for any loss caused by natural disasters or improper product use. Copying or reprinting the contents described in this material in whole or in part is prohibited without our prior permission.

HAMAMATSU

www.hamamatsu.com

HAMAMATSU PHOTONICS K.K., Solid State Division

1126-1 Ichino-cho, Higashi-ku, Hamamatsu City, 435-8558 Japan, Telephone: (81) 53-434-3311, Fax: (81) 53-434-5184

U.S.A.: Hamamatsu Corporation: 360 Foothill Road, Bridgewater, N.J. 08807, U.S.A., Telephone: (1) 908-231-0960, Fax: (1) 908-231-1218

Germany: Hamamatsu Photonics Deutschland GmbH: Arzbergerstr. 10, D-82211 Herrsching am Ammersee, Germany, Telephone: (49) 8152-375-0, Fax: (49) 8152-265-8

France: Hamamatsu Photonics France S.A.R.L.: 19, Rue du Saule Trapu, Parc du Moulin de Massy, 91882 Massy Cedex, France, Telephone: 33-(1) 69 53 71 00, Fax: 33-(1) 69 53 71 10

United Kingdom: Hamamatsu Photonics UK Limited: 2 Howard Court, 10 Tewin Road, Welwyn Garden City, Hertfordshire AL7 1BW, United Kingdom, Telephone: (44) 1707-294888, Fax: (44) 1707-325777

North Europe: Hamamatsu Photonics Norden AB: Torshamnsgatan 35 16440 Kista, Sweden, Telephone: (46) 8-509-031-00, Fax: (46) 8-509-031-01

Italy: Hamamatsu Photonics Italia S.r.l.: Strada della Moia, 1 int. 6, 20020 Arese (Milano), Italy, Telephone: (39) 02-93581733, Fax: (39) 02-93581741

China: Hamamatsu Photonics (China) Co., Ltd.: B1201, Jiaming Center, No.27 Dongsanhuan Beilu, Chaoyang District, Beijing 100020, China, Telephone: (86) 10-6586-6006, Fax: (86) 10-6586-2866