

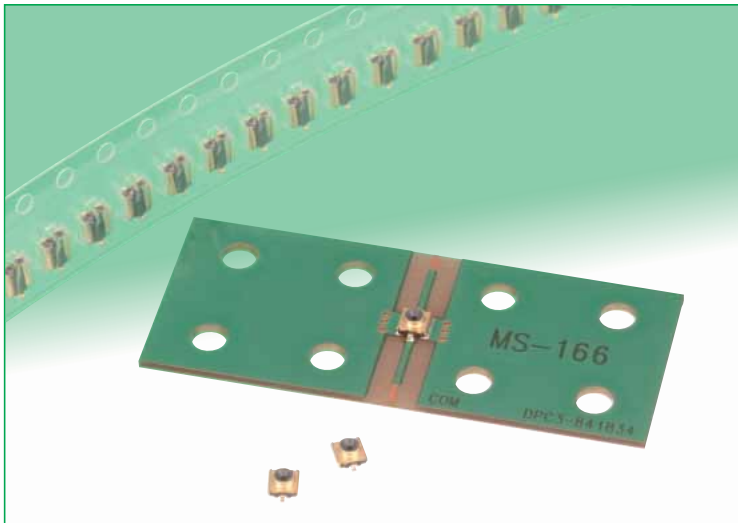

Subminiature Coaxial Switch 1.2 mm High, DC to 11 GHz

MS-166 Series



Space-saving design
 Low profile -1.2 mm protrusion above the board.
 Lightweight -0.016 g. total weight.

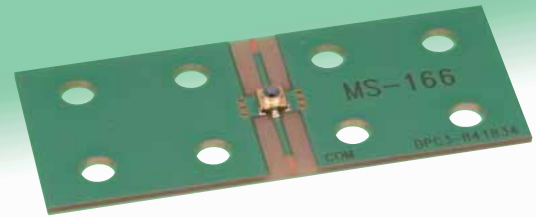

Overview

Developed for inspection of high frequency circuits used in portable terminals. Verification of the circuit performance is accomplished by simply inserting the external plug in the board mounted receptacle. This action re-directs the circuit from normal condition to the plug side. Removing the plug restores circuit to its normal condition.

Features

1. Low insertion loss

- 0.15 dB typical at 2.5 GHz (not mated with the plug).
- 0.2 dB typical at 6 GHz (not mated with the plug).
- 0.4 dB typical at 11 GHz (not mated with the plug).

2. Space-saving design

2.3 mm x 2.3 mm occupied board space.

3. Low profile

1.2 mm protrusion above the board.

4. Lightweight

0.016 g. total weight (without vacuum cap).

5. Miniaturization of Equipment Holes

The outside diameter of the tip of the plug connectors is a narrow 2.8 mm which permits a great reduction in the size of the equipment holes.

6. Durability

50 mating/unmating cycles, with corresponding plug.

7. Performs over a wide frequency range

Applicable frequencies range over a wide band, from DC to 11 GHz.

8. Board placement with automatic equipment

Packaged on tape-and-reel. Also available with a vacuum pick-up cap over each switch.

9. RoHS compliant

All components and materials comply with the requirements of the EU Directive 2002/95/EC.

Applications

Portable terminals, ETC, notebook computers (Bluetooth), wireless LAN, POS terminals, GPS terminals, PDA, and any small devices requiring verification of antenna/circuit performance.

Comparison with the existing MS-156HF

MS-156HF

MS-166

Footprint

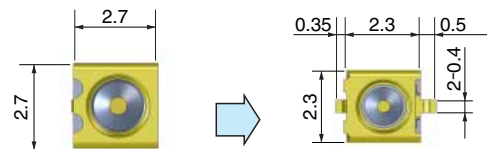

22% saving of space

Height



25% lower profile

Weight

0.025g → 0.016g

36% lighter weight

SMA conversion adapters



MS-166 Series Subminiature Coaxial Switch 1.2 mm High, DC to 11 GHz

Product Specifications

	Not mated with the plug	Open Mated with (MS-166-HRMJ-1)
Operating temperature range	-40°C to +85°C	
Rated power	2W	
Frequency range	DC to 11GHz	DC to 8GHz
V.S.W.R.	1.2 max. (DC to 2.5GHz) 1.3 max. (2.5GHz to 6GHz) 1.5 max. (6GHz to 11GHz)	1.4 max. (DC to 3GHz) 1.8 max. (3GHz to 8GHz)
Insertion loss	0.15 dB max. (DC to 2.5GHz) 0.2 dB max. (2.5GHz to 6GHz) 0.4 dB max. (6GHz to 11GHz)	0.5 dB max. (DC to 3GHz) 0.7 dB max. (3GHz to 8GHz)
Isolation loss	—————	20 dB min. (DC to 3GHz) 15 dB min. (3GHz to 6GHz) 12 dB min. (6GHz to 11GHz)

Item	Specification	Conditions
1. Contact resistance	100 mΩ max.	100 mA
2. Insulation resistance	1000 MΩ min.	100 V DC
3. Withstanding voltage	No flashover or insulation breakdown	100 V AC / 1 minute
4. Vibration	No electrical discontinuity of 1 μs or longer	Frequency: 10 to 55 Hz, single amplitude of 1.5 mm, 2 hours in each of the 3 axis.
5. Thermal shock	No electrical discontinuity of 1 μs or longer	Acceleration of 490 m/s ² , 6 ms duration, sine half-wave waveform, 3 cycles in each of the 3 axis.
6. Temperature cycle	Contact resistance: 100 mΩ max. Insulation resistance: 10 MΩ min.	Temperature: -55°C → +15°C to +35°C → +85°C → +15°C to +35°C Time: 30 → 2 to 3 → 30 → 2 to 3 (Minutes) 100 cycles
7. High temperature exposure	Contact resistance: 100 mΩ max. Insulation resistance: 10 MΩ min.	96 hours at 85°C
8. Low temperature exposure	Contact resistance: 100 mΩ max. Insulation resistance: 10 MΩ min.	96 hours at -55°C
9. Humidity	Contact resistance: 100 mΩ max. Insulation resistance: 10 MΩ min.	96 hours at 40±2°C, and humidity of 90 to 95%
10. Durability (mating/un-mating, with corresponding plug)	Contact resistance: 100 mΩ max.	50 cycles

Materials

Part	Material	Finish	Remarks
Shell	Phosphor bronze	Gold plated	—————
Insulator A	LCP	—————	UL94V-0
Insulator B	Polyamide		UL94HB
Common terminal	Beryllium copper	Partially gold plated	—————
Antenna terminal	Phosphor bronze	Partially gold plated	—————

◆ High Frequency Characteristics (Typical)

● NORMALLY CLOSED(N.C) ~ (Not mated with the plug)

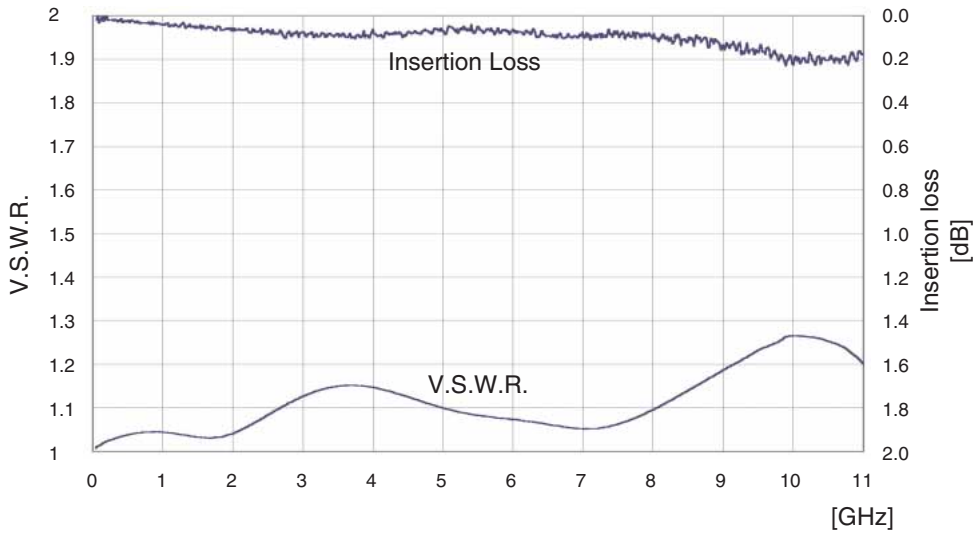

● OPEN(N.O) ~ (Mated with the plug)

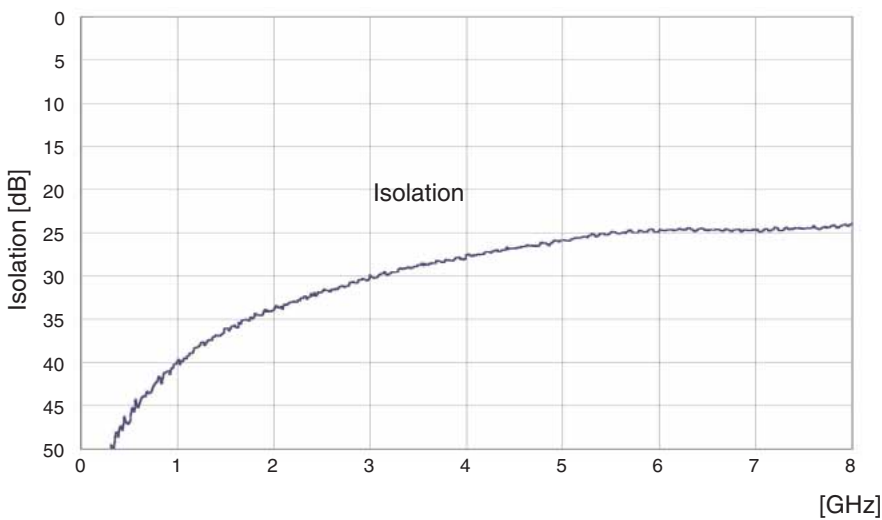
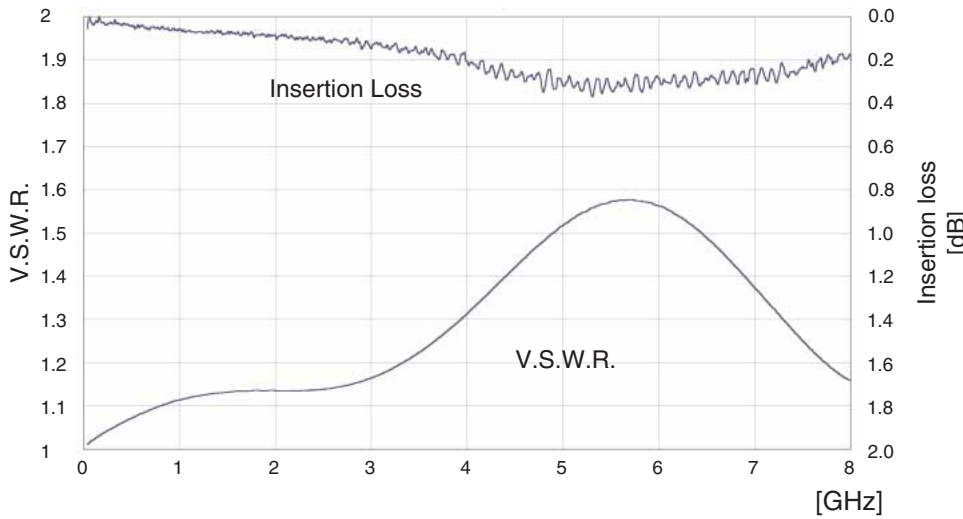

MS-166 Series Subminiature Coaxial Switch 1.2 mm High, DC to 11 GHz

Receptacle

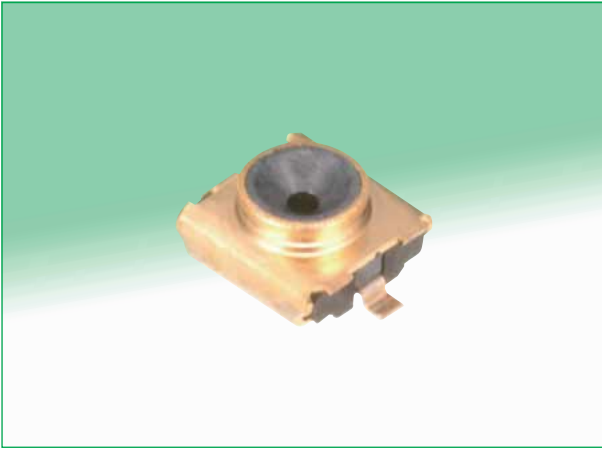

Part Number	CL No.	Packaging
MS-166	358-0229-3	2,000 pieces/reel
MS-166 (01)	358-0229-3-01	10,000 pieces/reel

Circuit diagram

Not mated with the plug (N.C)

Mated with the plug (N.O)

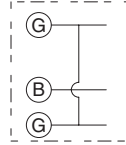

MS-166 Plug

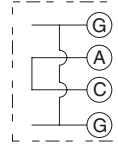

MS-166

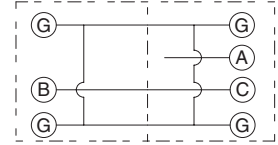

MS-166 Plug

MS-166

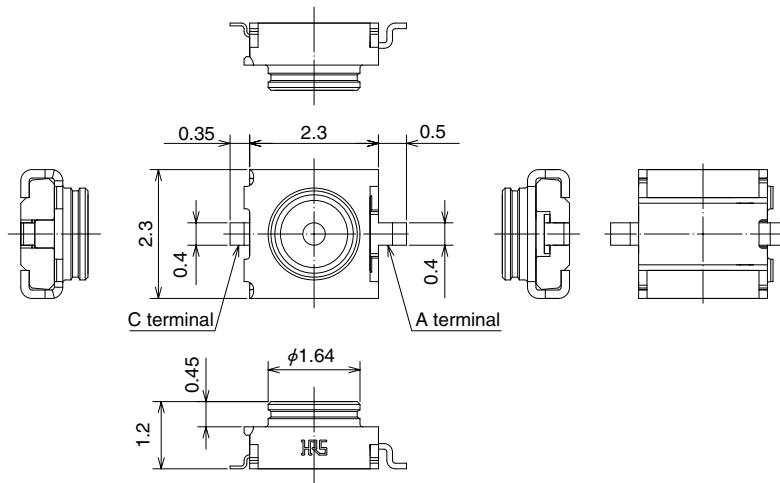

Recommended PCB mounting pattern and metal mask dimensions

PCB mounting pattern

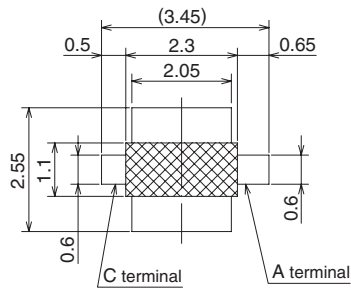

Metal mask dimensions

0.1 to 0.12mm thick

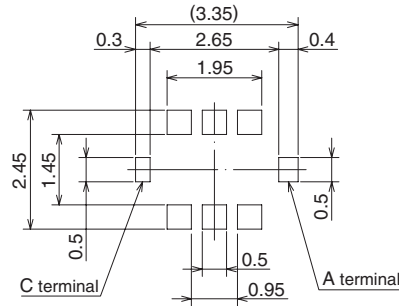

area show the conductive pattern prohibited area.

◆ Precautions

1. Do not use the washing process.
2. This product is intended to be used for circuit inspection only. Consult us if any other application is considered.
3. Plugs can be roughly classified to two types.
 - For mass production line automatic check (Press down type)
 - For manual check (With retentive lock) : Unable to be used at production line.
4. Do not use hand soldering for mounting of MS-166.
Doing so could result in solder and flux wicking to the contact areas.
5. When using a heat gun, hot plate, or similar methods, limit the temperature to 260°C applied for 10 seconds max.
6. Cross-hatched area shown on the PCB mounting pattern must be free of any conductive traces. Placing conductive traces in this area may affect performance and will void product warranties. When the bottom surface of the product (i.e., the  shaded area of the specified land dimensions diagram on the previous page) has been processed with a substrate copper trace and resist processing, Hirose Electric will not be able to warrant the product.
7. Please refrain from using the product in environments specifically affected by excessive vibration, shock, dust, high humidity, gases, very high temperatures and very low temperatures such as outdoor equipment. It might cause degradation or destruction of the product. Even if it endures during a short time, long time quarification is not quaranteed.
8. Exercise caution as not to allow any debris to enter the board mounted MS-166 when cutting PCB.

MS-166 Series ● Subminiature Coaxial Switch 1.2 mm High, DC to 11 GHz

◆ Recommended Temperature profile

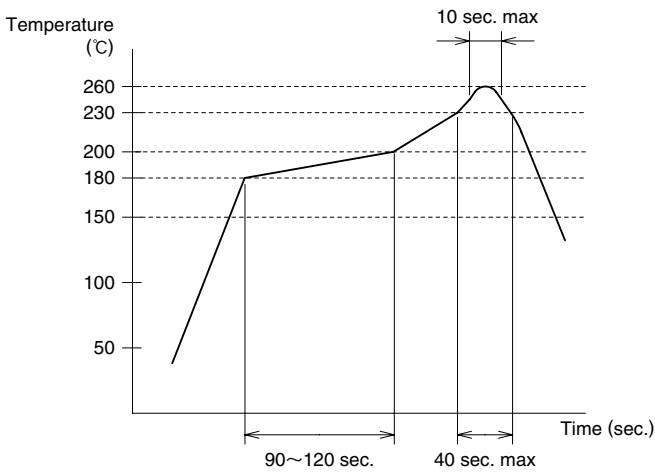

● Typical Lead-free Solder Paste

①	Maximum temperature	: 260°C
②	Peak temperature time	: 10 sec. max.
③	230°C min.	: 40 sec. max.
④	180°C to 200°C	: 90 to 120 sec. max.

Metal mask thickness: 0.1 to 0.12mm

Reflow cycles: 2 cycles

◆ Packaging Specifications

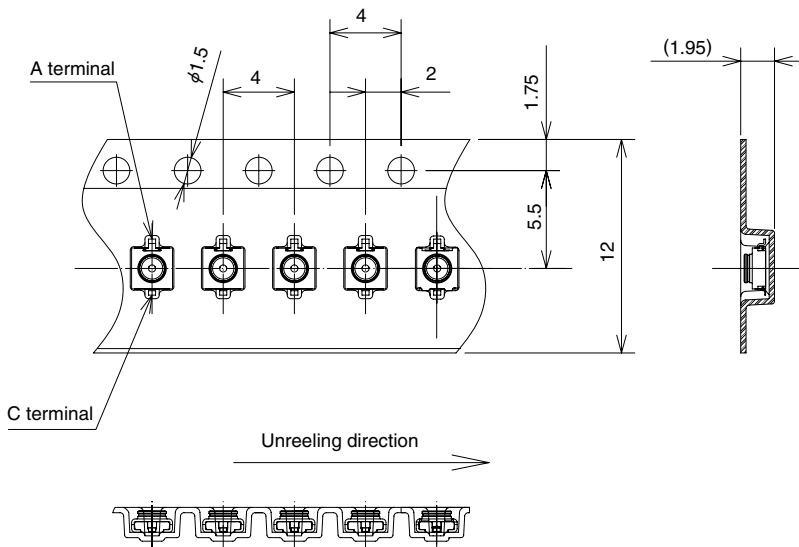

● Reel dimensions

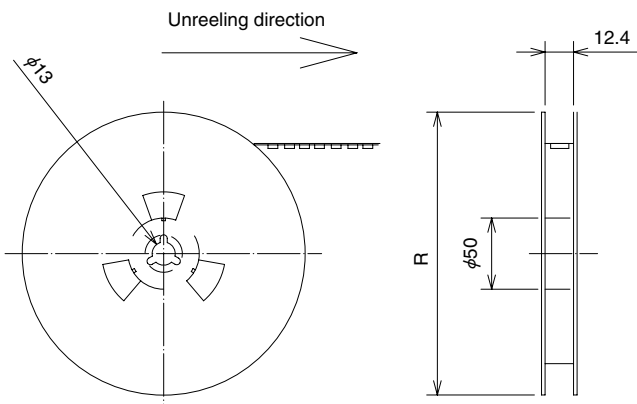

Part Number	Reel diameter	Packaging
MS-166	180 mm	2,000 pieces/reel
MS-166 (01)	380 mm	10,000 pieces/reel

■ SMA Conversion Adapters

● Press down, with flange

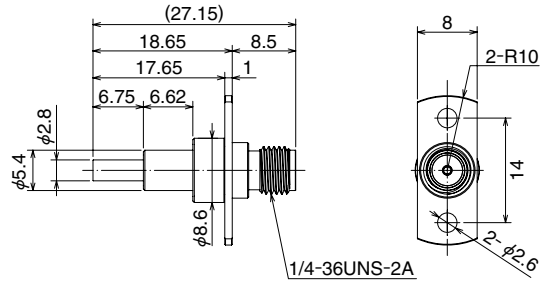
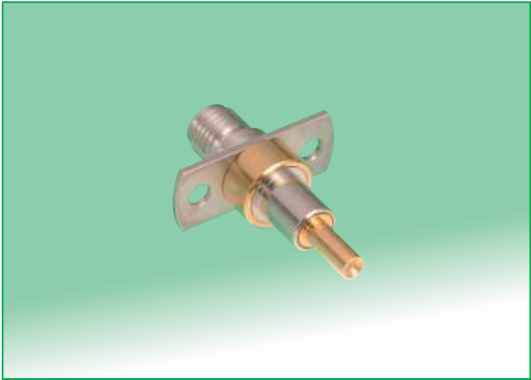

Part Number	CL No.	Durability
MS-166-HRMJ-1	358-0239-7	10,000 Times

- Mates perpendicularly with the MS-166 and should be used with a load of 5.5 to 10 N applied.
- The service life has a plug connector single item guaranty and not the guaranty associated with the same receptacle.

● Floating

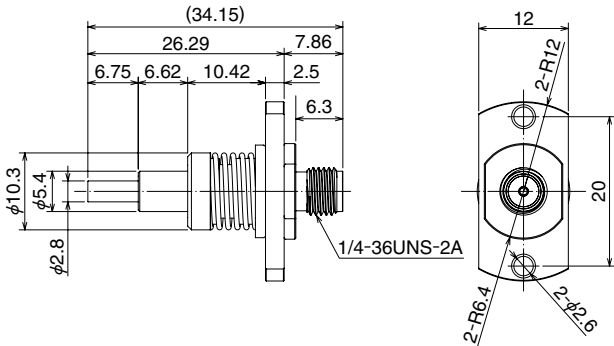
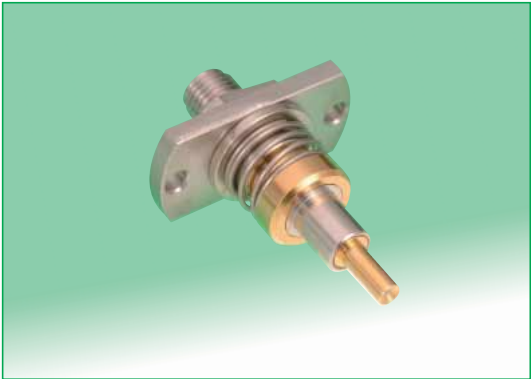

Part Number	CL No.	Durability
MS-166-HRMJ-F1	358-0230-2	10,000 Times

- Mates perpendicularly with the MS-166 and should be used in specified the spring stroke range of this product.
- The service life has a plug connector single item guaranty and not the guaranty associated with the same receptacle.

● Simplified lock, straight

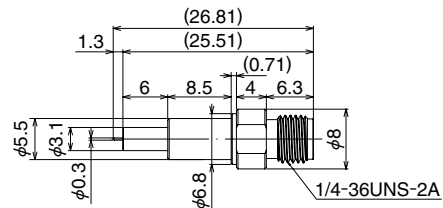
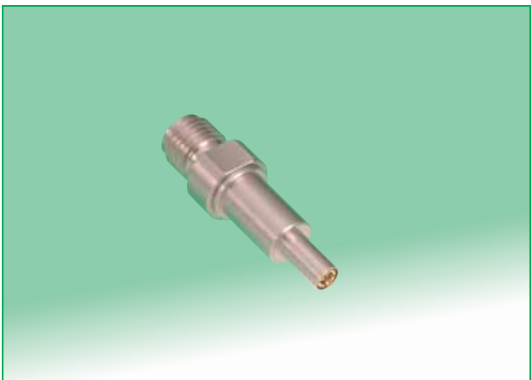

Part Number	CL No.	Durability
MS-166-HRMJ-H1	358-0241-9	500 Times

- Equipped with an easy lock mechanism that can maintain mating with the MS-166, but should be used while maintaining a condition of mating perpendicularly.
- The service life has a plug connector single item guaranty and not the guaranty associated with the same receptacle.