

Data sheet | Item number: 769-635

THT male header; 1.0 x 1.0 mm solder pin; straight; Pin spacing 5 mm; 5-pole

www.wago.com/769-635

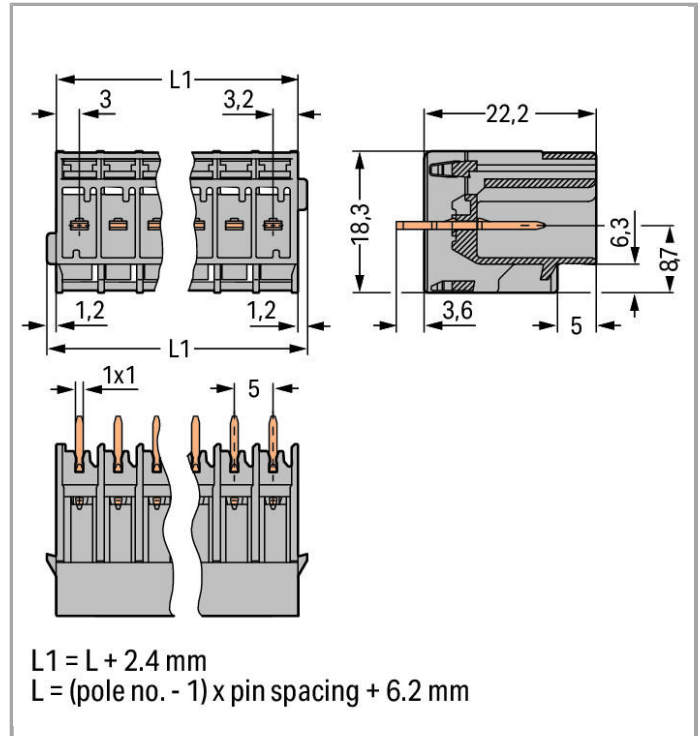

RoHS Compliant



Color: ■

Data

Electrical data

Ratings per IEC/EN 60664-1

Rated voltage (III / 3)	250 V
Rated impulse voltage (III / 3)	4 kV
Rated voltage (III / 2)	500 V
Rated impulse voltage (III / 2)	4 kV
Rated current	32 A

Connection data

No. of poles	5
--------------	---

Total number of potentials	5
Number of levels	1

Geometrical Data

Pin spacing	5 mm / 0.197 inch
Width	28.6 mm / 1.126 inch
Height from the surface	22.2 mm / 0.874 inch
Depth	18.3 mm / 0.72 inch
Plug width	28.6 mm / 1.126 inch
Solder pin dimensions	Solder pin 1 x 1 mm

Plug connection

Contact type (pluggable connector)	Male connector/plug
Connector connection type	for PCBs
Mismating protection	No
Mating direction to the PCB	90°

PCB contact

PCB contact	THT
-------------	-----

Material Data

Color	gray
Insulating material	Polyamide 66 (PA 66)
Fire load	0.113 MJ
Weight	5.267 g

Commercial data



Product Group	18 (X-COM-System)
Country of origin	PL
GTIN	4044918270656

Approvals / Certificates



Country specific Approvals

Logo	Approval	Additional Approval Text	Certificate name
	CCA	IEC 61984	NL-47799
	CCA	EN 61984	2190419.02



	CCA DEKRA Certification B.V.	EN 60947	NTR NL- 7626
	CSA DEKRA Certification B.V.	C22.2 No. 158	1101144
	KEMA/KEUR DEKRA Certification B.V.	EN 60947	2190419.01

UL-Approvals

Logo	Approval	Additional Approval Text	Certificate name
	UR Underwriters Laboratories Inc.	UL 1059	E45172
	UR Underwriters Laboratories Inc.	UL 1977	E45171

Compatible products

Coding















Item no.: 769-435 Coding pin; for coding of female plugs; for carrier terminal blocks / male connectors	www.wago.com/769-435
---	--









Marking accessories

Item no.: 210-831 Marking strips; on reel; 2.3 mm wide; plain; Self-adhesive	www.wago.com/210-831
Item no.: 210-832 Marking strips; on reel; 3 mm wide; plain; Self-adhesive	www.wago.com/210-832
Item no.: 210-833 Marking strips; on reel; 6 mm wide; plain; Self-adhesive	www.wago.com/210-833
Item no.: 210-834 Marking strips; on reel; 5 mm wide; plain; Self-adhesive	www.wago.com/210-834

Female plug

Item no.: 769-101 1-conductor female plug; 4 mm ² ; 1-pole	www.wago.com/769-101
---	--

	Item no.: 769-102 1-conductor female plug; 4 mm ² ; 2-pole	www.wago.com/769-102
	Item no.: 769-102/000-036 1-conductor female plug; 4 mm ² ; 2-pole	www.wago.com/769-102/000-036
	Item no.: 769-102/000-037 1-conductor female plug; 4 mm ² ; 2-pole	www.wago.com/769-102/000-037
	Item no.: 769-103 1-conductor female plug; 4 mm ² ; 3-pole	www.wago.com/769-103
	Item no.: 769-103/000-036 1-conductor female plug; 4 mm ² ; 3-pole	www.wago.com/769-103/000-036
	Item no.: 769-103/000-037 1-conductor female plug; 4 mm ² ; 3-pole	www.wago.com/769-103/000-037
	Item no.: 769-103/000-038 1-conductor female plug; 4 mm ² ; 3-pole	www.wago.com/769-103/000-038
	Item no.: 769-103/000-039 1-conductor female plug; 4 mm ² ; 3-pole	www.wago.com/769-103/000-039
	Item no.: 769-104 1-conductor female plug; 4 mm ² ; 4-pole	www.wago.com/769-104
	Item no.: 769-104/000-036 1-conductor female plug; 4 mm ² ; 4-pole	www.wago.com/769-104/000-036
	Item no.: 769-104/000-037 1-conductor female plug; 4 mm ² ; 4-pole	www.wago.com/769-104/000-037
	Item no.: 769-104/000-038 1-conductor female plug; 4 mm ² ; 4-pole	www.wago.com/769-104/000-038
	Item no.: 769-104/000-039 1-conductor female plug; 4 mm ² ; 4-pole	www.wago.com/769-104/000-039
	Item no.: 769-105 1-conductor female plug; 4 mm ² ; 5-pole	www.wago.com/769-105
	Item no.: 769-105/000-036 1-conductor female plug; 4 mm ² ; 5-pole	www.wago.com/769-105/000-036
	Item no.: 769-105/000-037 1-conductor female plug; 4 mm ² ; 5-pole	www.wago.com/769-105/000-037

	Item no.: 769-105/000-038 1-conductor female plug; 4 mm ² ; 5-pole	www.wago.com/769-105/000-038
	Item no.: 769-105/000-039 1-conductor female plug; 4 mm ² ; 5-pole	www.wago.com/769-105/000-039
	Item no.: 769-105/021-000 1-conductor female plug; Locking lever; 4 mm ² ; 5-pole	www.wago.com/769-105/021-000
	Item no.: 769-121 2-conductor female connector; 4 mm ² ; 1-pole	www.wago.com/769-121
	Item no.: 769-122 2-conductor female connector; 4 mm ² ; 2-pole	www.wago.com/769-122
	Item no.: 769-123 2-conductor female connector; 4 mm ² ; 3-pole	www.wago.com/769-123
	Item no.: 769-124 2-conductor female connector; 4 mm ² ; 4-pole	www.wago.com/769-124
	Item no.: 769-125 2-conductor female connector; 4 mm ² ; 5-pole	www.wago.com/769-125

Downloads

CAD/CAE - Smart Data

CAD data

	URL	Download
3D Download 769-635		

Product family

X-COM

[Show all products from the family](#)

Subject to changes.